



Since
1959





WELCOME

As HD RUBBER; the satisfaction of our customers is the most important part of our business. We instill customer satisfaction awareness in all our employees and suppliers. Quality is the responsibility of all HD RUBBER employees. We see HD RUBBER employees as the key to our success and offer to opportunity to improve themselves continuously. Our target is to attract our suppliers to our own quality level and to provide mutual benefits.

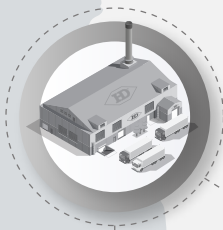

1959
HD Rubber started its operations in izmir

1983
Export adventure started

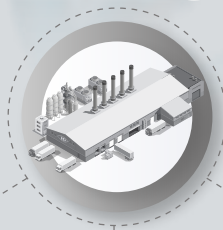
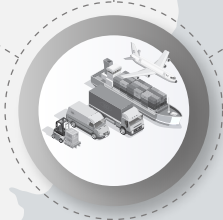

2011
Moved to Denizli with aim of being under one roof

2017
The Design Center was established and IATF 16949 certification has been completed

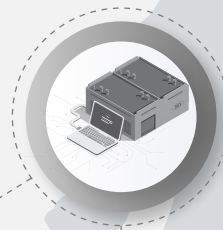

2019
Air Springs manufacturing facility established. Production Tracking Software was commissioned



Since
1959

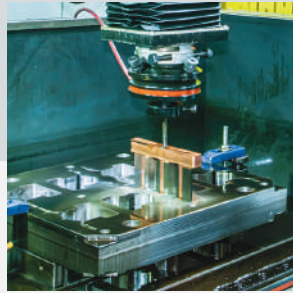

ONE STEP
AHEAD
IN ITS
REGION



EVERY
WHERE
IN THE
WORLD





Table Of Contents

Welcome

02-03

Contents

04-05

About The Company

06-07

Production Field

08-09

Rubber And Metal Parts

12

Air Springs

13



Engine Mounting

14

Propeller Shafts

15

Spring Mounting

16

Repair Kits

17

Bushing Parts

18

Quality & Test Methods

19-20

Factory Overview

21

All members of the society are responsible to the environment. With this awareness, we encourage all of our stakeholders in this regard as an environmentally conscious business. As the HD RUBBER family, it is our most important feature to respect each other. We aim to be an HD RUBBER that wants to be worked with this feature.



About The Company

HD Rubber, which produces rubber-metal based suspension parts for heavy duty vehicles and trailers, has started its automotive business activities in İzmir in 1959.

Our company moved all production facilities to Denizli in 2011 and continues its activities with 3.000 tons rubber parts and 800.000 air spring production capacity in 30.000 m2 building area. With the young and dynamic staff, HD has taken place between the companies which diverts the automotive spare part sector with its wide range and trusted service.

HD Rubber designs and manufactures molds in its own design center using computer-aided manufacturing, computer-aided design programs, reverse engineering programs and devices (SolidWorks, Siemens NX, CIMATRONE, Moblex 3D, Geomagic Design X, Geomagic Control X, Simscan 30 3D Scanner). Our design center has been approved on June 2017, by the Turkish ministry of industry and commerce. We also get into way of Industry 4.0 by establishing robotic chemosil painting unit and zincphosphate unit.

HD Rubber, is aiming to deliver low cost but high quality products to its customers with the guidance standards of IATF 16949 and ISO 9001. HD RUBBER continues its export activities with 5 continents and more than 70 countries since 1983. HD Rubber is also proud of being a leading company of Turkey.

Vision

To be an exemplary and preferred global company in the automotive sector both in the country and abroad with its values.

Mission

To provide products and services focused on customer satisfaction, which always takes technology as a guide, respects people and nature, aims the development of itself and its suppliers, and complies with global quality values and standards.





Our values

- **Environmentalist**
Our company is to leave a livable world to future generations by making continuous improvements in order to reduce its environmental impacts and increase sustainability.
- **Customer-Oriented**
As a customer-oriented organization, to design, produce, deliver the product on time, manage customer feedback effectively, and ensure the continuity of our products and services.

- **Fair**
To provide a fair environment and opportunities that give confidence to its employees and customers.
- **Progressive**
To turn employees into stakeholders who continuously develop technically and personally, thus acting together with team spirit, responsible, able to make decisions, and embracing company values.
- **Innovative**
Always adapting to new technologies with the ideas of the employees and adding new products to the production range thanks to the effective design center.
- **Global**
To spread our products to every region of the world by offering products and services that meet the needs of the whole world, increasing the number of companies we export every year.



PRODUCTION & FIELD

HD RUBBER is a leading manufacturer of air springs, cabin bellows, rubber parts and rubber to metal parts such as spring mountings, engine mountings, rubber mountings, spring bushings, axle bushings, other bushings and mountings for trucks, buses, heavy-duty vehicles and trailers. All of products are produced in accordance with IATF 16949 and ISO 9001 quality certificates.

The parts suitable for AGRALE, BMC, BOVA, BPW, DAF, DENNIS, EVOBUS, FORD, FREIGHTLINER, ISUZU, IVECO, KENWORTH, MACK, MAN, MERCEDES-BENZ, NEOPLAN, PETERBILT, RENAULT, SAF HOLLAND, SCANIA, SETRA, SOLARIS, TEMSA, VAN HOOL, VDL, WOLKSWAGEN, VOLVO (Brand names are used just for informational purposes, and it is not implied that any listed part is the product of these manufacturers).

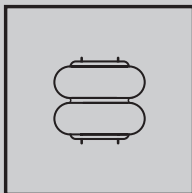

Air Spring Manufacturing

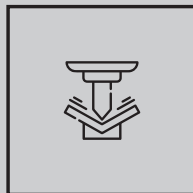

Sheet-Metal Forming

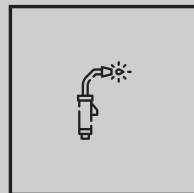

Molding, Welding

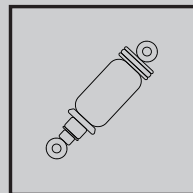

Cabin Bellows

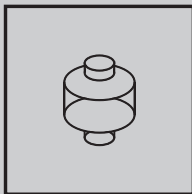

Rubber Metal & Vulcanization

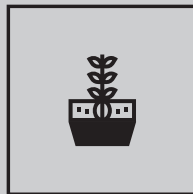

Compound Mixing Area

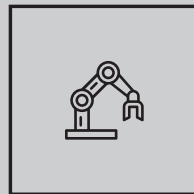

6 Axes Welding Robot

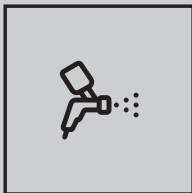

Wet And Dry Paint Facility

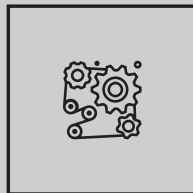

Machining Process

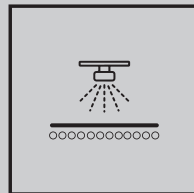

Surface Coating Process

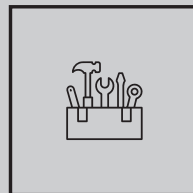

Toolshop





CABIN & SEAT AIR SPRINGS LINE

The cabin bellows are used in the driver's compartment of heavy-duty commercial vehicles. They provide insulation from disruptive vibrations and help reduce the possibility of accidents caused by fatigue. They create a more ergonomic and comfortable working environment inside the cabin



MACHINING LINE

We are able to respond to our customers' demands quickly with our facility, which incorporates various technologies and offers superior labor convenience. Metal parts machining operations are carried out with CNC lathe, CNC lathe with driven tools, CNC machining center, and double-table CNC machining centers



COMPOUND MIXING LINE

Automation Controlled Compound Production: Compound production is carried out with full control through automatic weighing and dosing, providing traceability





Rubber And Metal Parts



Air Springs





Engine Mounting

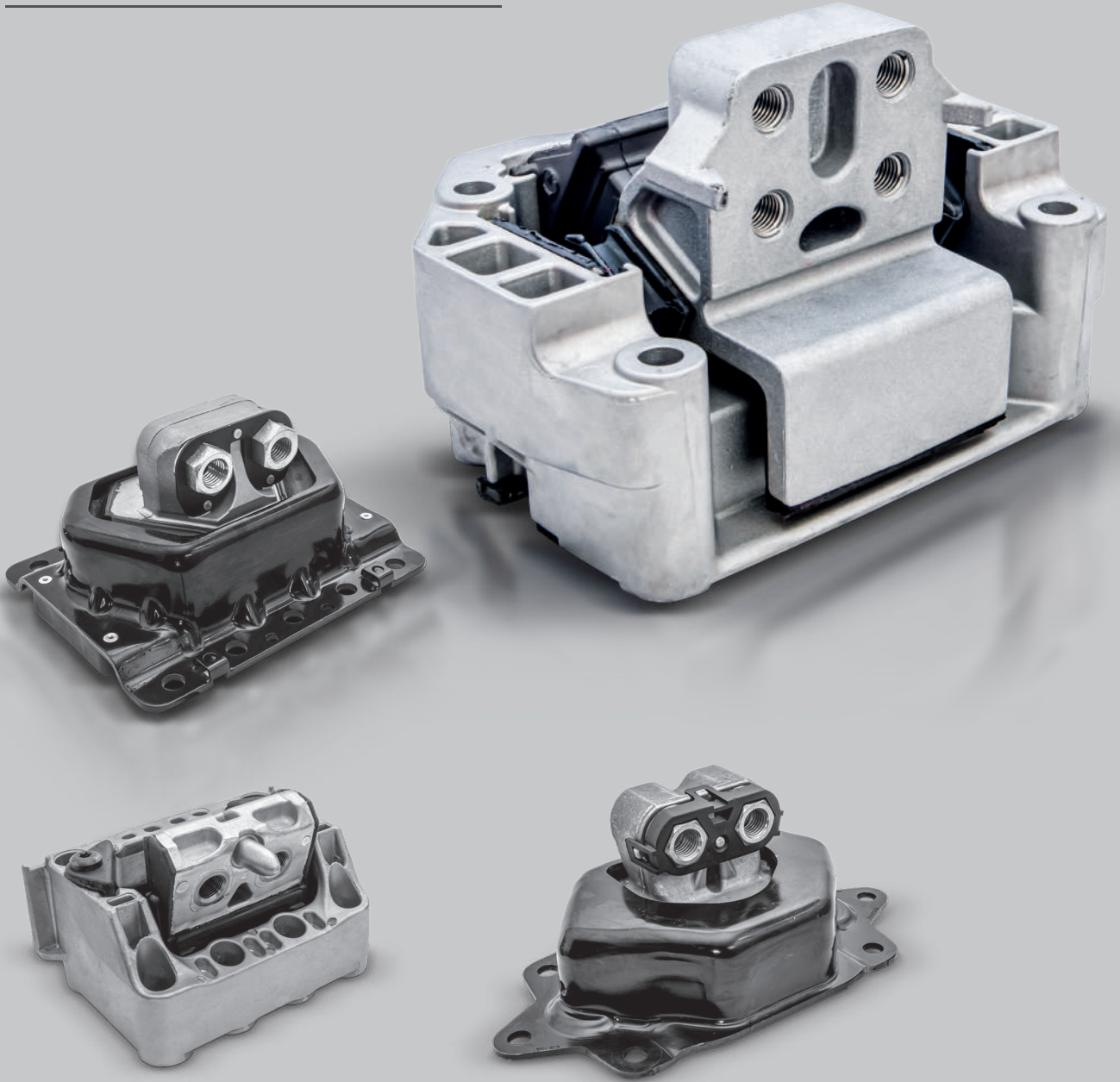

Propeller Shafts

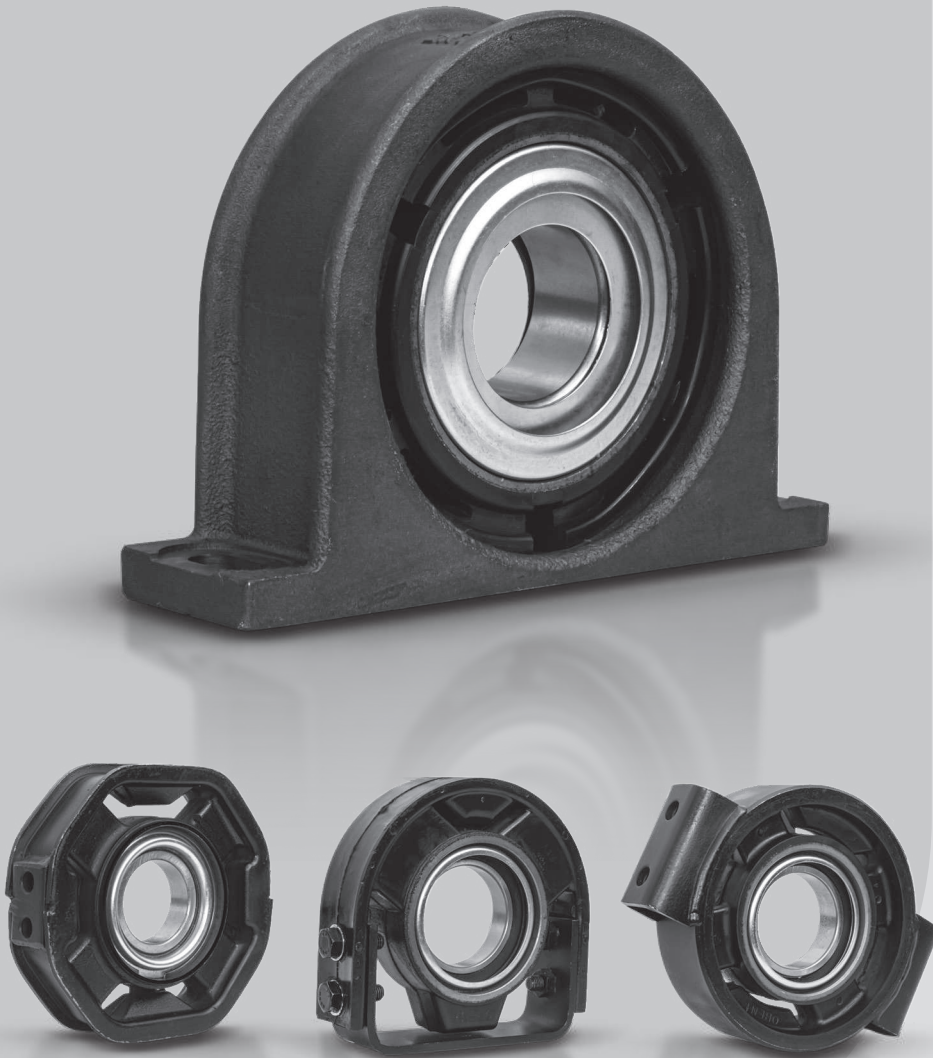



Spring Mounting

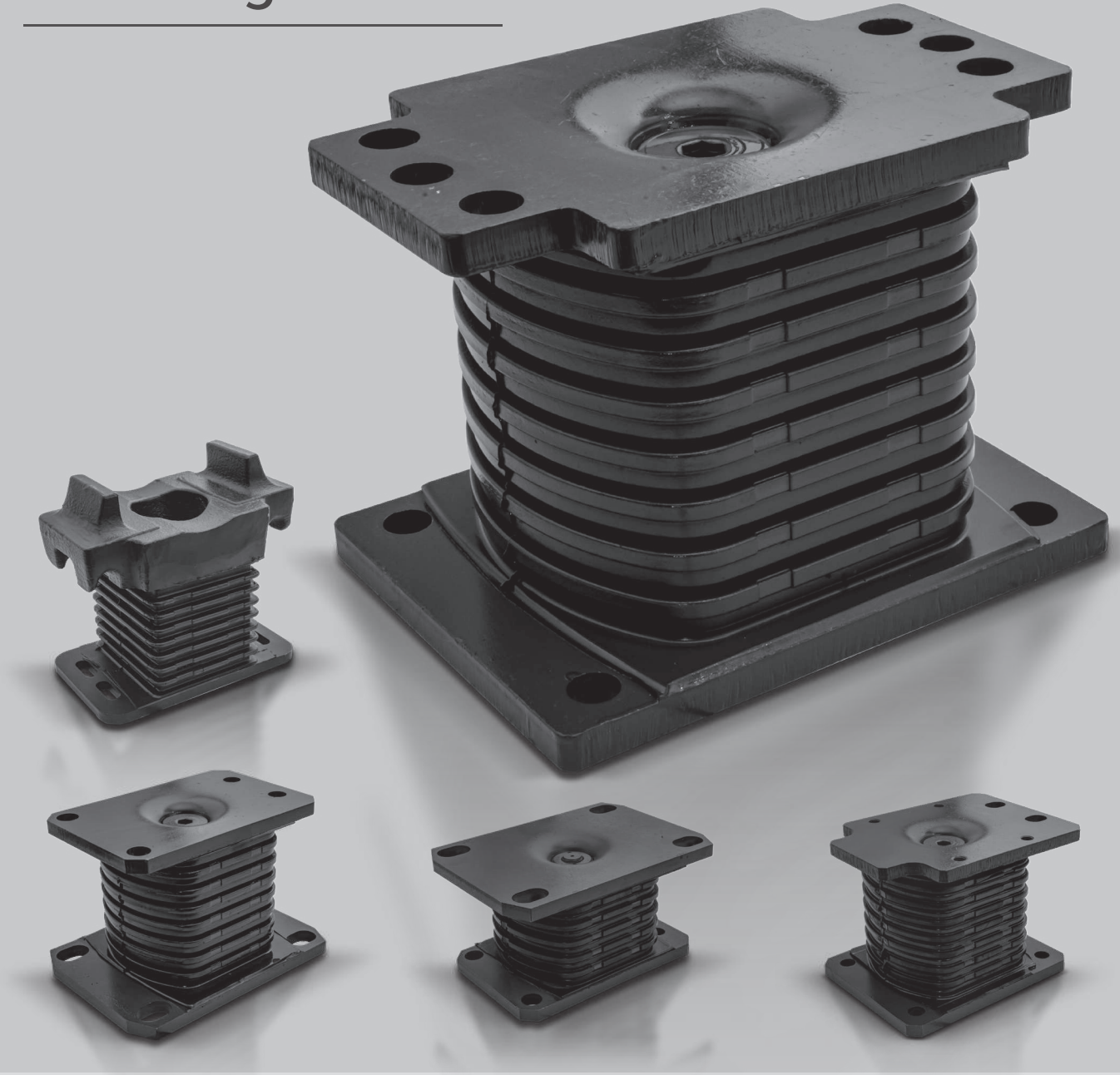



Repair Kits

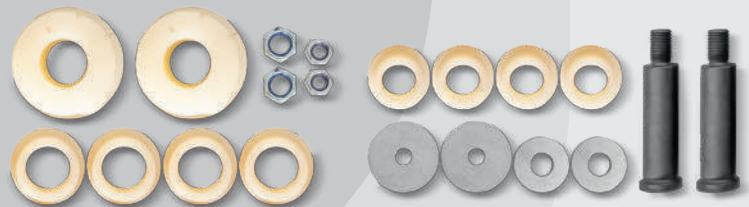
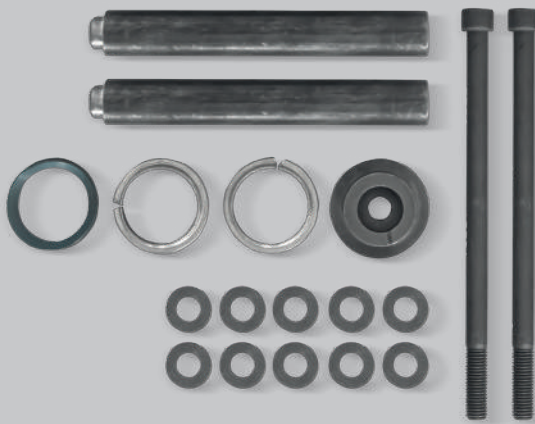



Bushing Parts

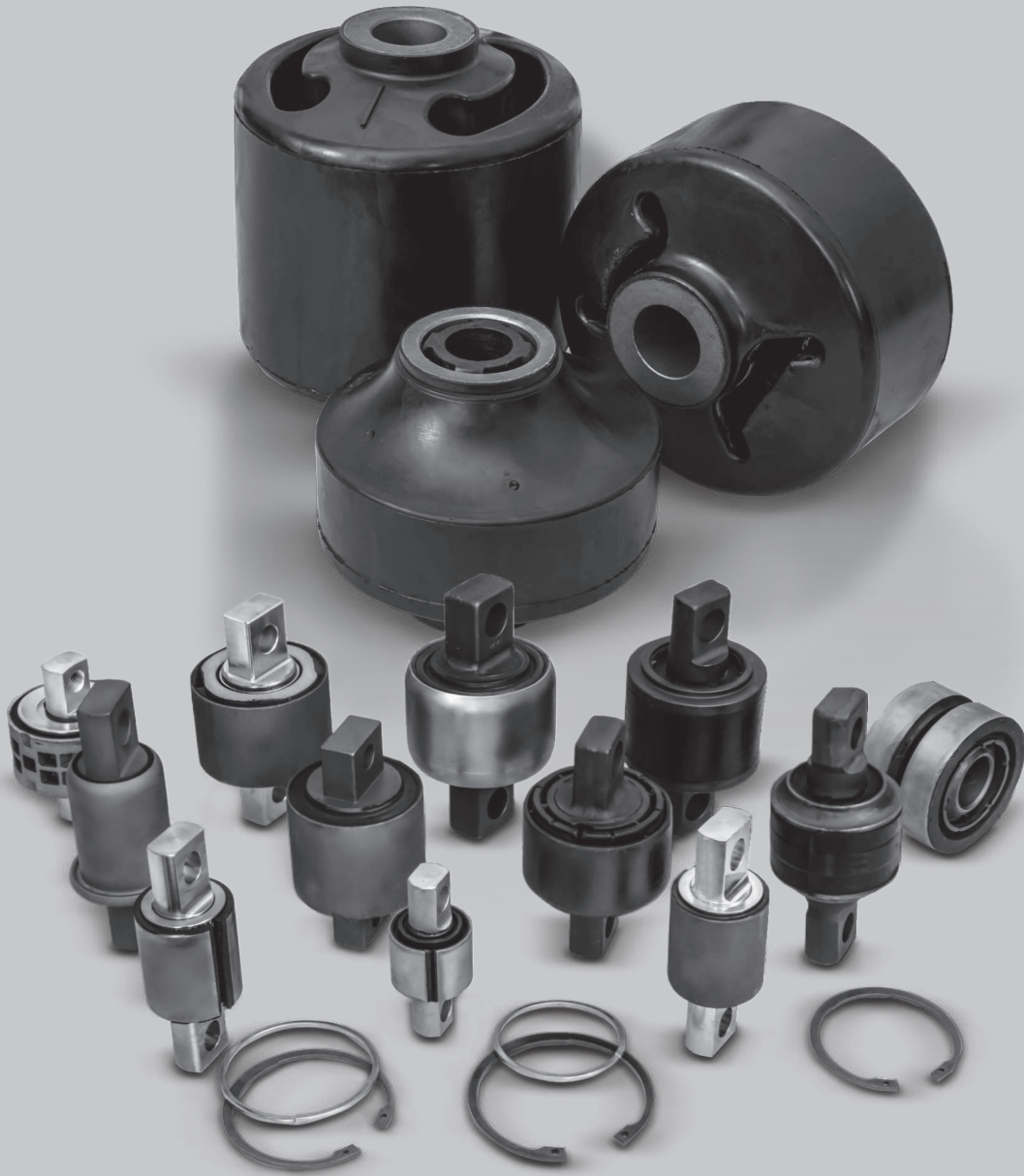

Quality & Test Methods

The satisfaction of our customers is the most important part of our business. We instill customer satisfaction awareness in all our employees and suppliers.

As HD RUBBER, the satisfaction of our customers is the most important part of our business. We instill customer satisfaction awareness in all our employee and suppliers. Quality is the responsibility of all HD RUBBER employees. We see HD RUBBER employees as the key to our success and offer to opportunity to improve themselves continuously. Our target is to attract our suppliers to our own

quality level and to provide mutual benefits. All members of the society are responsible to the environment. With this awareness, we encourage all of our stakeholders in this regard as an environmentally conscious business. As the HD RUBBER family, it is our most important feature to respect each other. We aim to be an HD RUBBER that wants to be worked with this feature.

**Rheometer
Test**

**Growth
Test**

**Pull Off
Test**

**Leaking
Test**

**Blasting
Test**

**Fatigue
Test**

Our Test Methods

Has been qualified for IATF 16949 and ISO 9001. Quality processes include input control, process quality control, and periodic inspection of products, mass production laboratory controls, product development process and performance controls, systems of quality assurance, supplier quality assurance, and warranty of quality management.

Besides, HD RUBBER serves following tests for its products in its own production facilities. IN AIR SPRINGS LINE: Growth Test, Fatigue Test, Blasting Test, Leaking Test (each air spring is subjected to 100% test). IN COMPOUND MIXING LINE: Rheometre Test, Pull Off Test. IN INJECTION LINE: Static Strength Test, Dynamic Strength Test.



Certification & Standards

ISO 9001

Quality is the responsibility of all HD Rubber employees. HD Rubber employees are the key to our success and the source of our continuous improvement.

IATF 16949

Our main goal is to provide quality products and services to our customers and potential customers in the automotive sector. In addition to this, our aim is to continuously improve by conducting risk and opportunity assessments within the framework of process management, and by instilling this understanding in our suppliers to ensure their compliance with our quality standards to achieve mutual benefits.

ISO 10002

As an organization that always prioritizes customer satisfaction, guaranteeing

the effective management of customer complaints and feedback is an indicator of the continuity of our products and services.

ISO 45001

Human is our most important value in our efforts to ensure competitive advantage in line with our main goal and to achieve our strategic goals. Taking the necessary measures to create a healthy and safe work environment for our employees and everyone who is on the factory site for work, internship or visit purposes is an indicator of our continuity.

ISO 14001

Our company shows our effort to leave a livable world to future generations by making continuous improvement in order to reduce its environmental impact and increase sustainability.



Tasarım Merkezi



ARCTIC OCEAN
Ocean

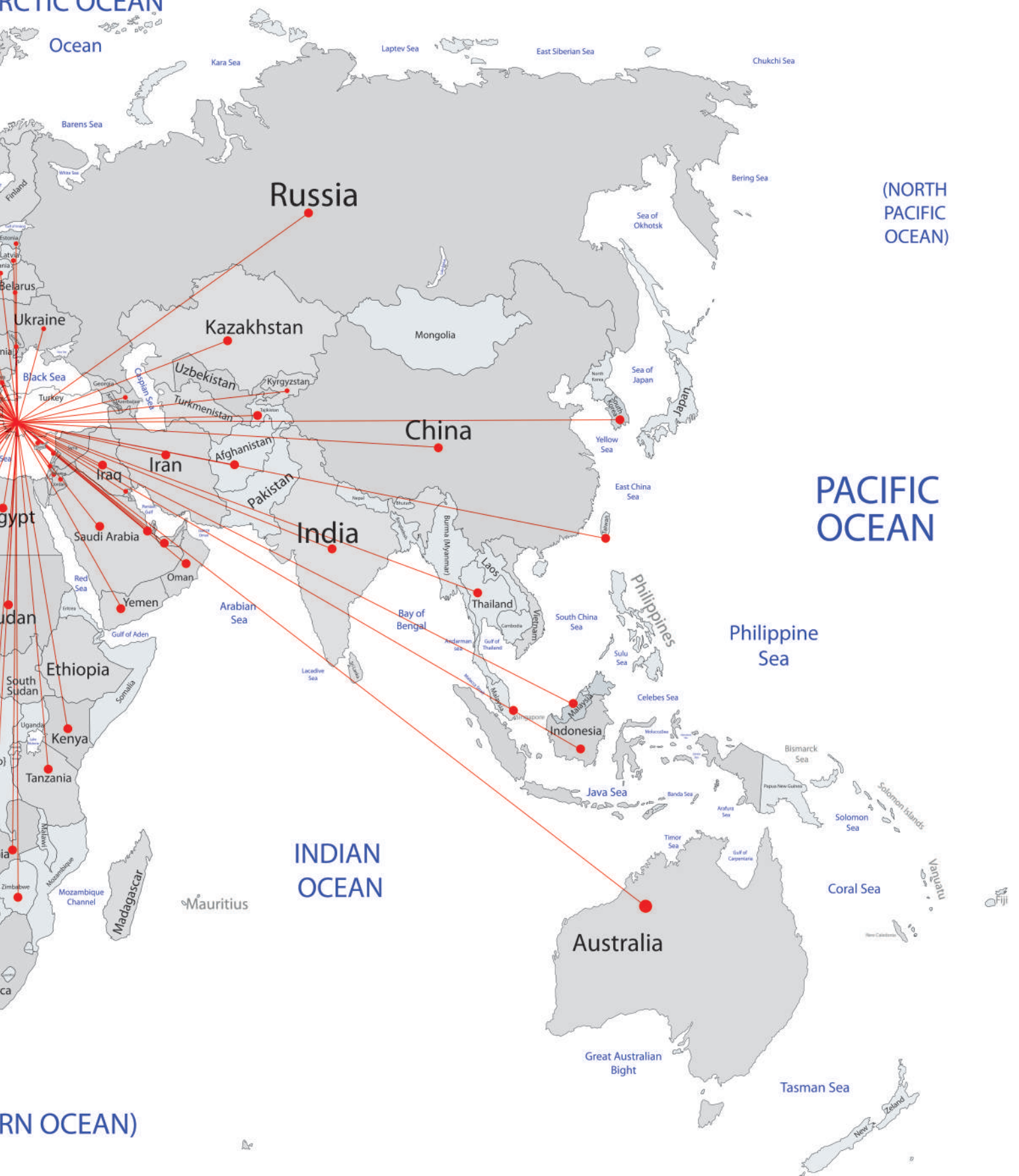

(NORTH
PACIFIC
OCEAN)

PACIFIC
OCEAN

INDIAN
OCEAN

ARCTIC OCEAN)

WE EXPORT TO **78 COUNTRIES**



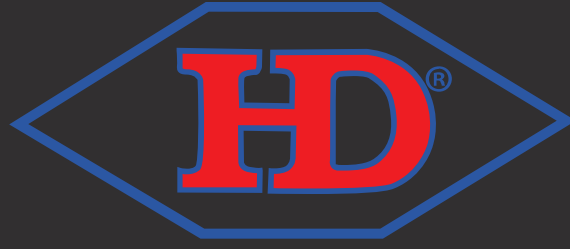

Since
1959

Bozburun Mah. 7101 SK.
Ateş Otomotiv Sitesi No:18
Merkezefendi, Denizli 20020, Türkiye

© +90 (0258) 371 71 91 © +90 (0258) 371 71 94



HD RUBBER



hdrubbber



hdrubbber



www.hd.com.tr