



# datka®

[www.datka.com.tr](http://www.datka.com.tr)



PRODUCT CATALOGUE

Your Reliable Partner in **TURKEY**

SINCE 2014

CODE	DIMENSIONS (mm)	BOX UNIT (NB)	SACK/BAG (NB)
D8001	20 x 1/2"	600	500
D8002	20 x 3/4"	450	360
D8003	25x 1/2"	300	240
D8004	25 x 3/4"	360	300
D8005	25 x 1"	250	200
D8006	32 x 1/2"	200	160
D8007	32 x 3/4"	200	160
D8008	32 x 1"	240	200
D8009	32 x 1 1/4"	175	140
D8010-1	40 x 3/4"	120	100
D8010	40 x 1"	120	100
D8011	40 x 1 1/4"	140	100
D8012	40 x 1 1/2"	110	90
D8013	50 x 1 1/4"	80	60
D8014	50 x 1 1/2"	80	60
D8015	50 x 2"	70	55
D8016	63 x 1 1/2"	60	40
D8017	63 x 2"	50	40
D8018	63 x 2 1/2"	50	35
D8019	75 x 2"	40	26
D8020	75 x 2 1/2"	40	26
D8021	75 x 3"	30	23
D8022	90 x 2"	24	16
D8023	90 x 2 1/2"	24	16
D8024	90 x 3"	24	16
D8025	90 x 4"	20	15
D8026	110 x 2"	12	8
D8027	110 x 2 1/2"	12	8
D8028	110 x 3"	12	8
D8029	110 x 4"	12	8

PN16

**Female Adaptor**

Муфта с внутренней резьбой

رأس خط سن داخلي

Adaptador con Rosca Interna  
Adaptador com Rosca Interna

CODE	DIMENSIONS (mm)	BOX UNIT (NB)	SACK/BAG (NB)
D8050	20 x 1/2"	720	540
D8051	20 x 3/4"	450	360
D8052	25 x 1/2"	375	300
D8053	25 x 3/4"	375	300
D8054	25 x 1"	300	240
D8055	32x 1/2"	250	200
D8056	32 x 3/4"	250	200
D8057	32 x 1"	250	200
D8058	32 x 1 1/4"	200	160
D8059-1	40 x 3/4"	140	100
D8059	40 x 1"	140	100
D8060	40 x 1 1/4"	140	100
D8061	40 x 1 1/2"	130	90
D8062-1	50 x 1"	100	70
D8062	50 x 1 1/4"	100	70
D8063	50 x 1 1/2"	90	70
D8064	50x2"	80	65
D8065	63 x 1 1/2"	56	43
D8066	63 x 2"	56	43
D8067	63 x 2 1/2"	50	40
D8068	75x2"	38	27
D8069	75 x 2 1/2"	38	27
D8070	75x3"	30	25
D8071	90x2"	22	16
D8072	90 x 2 1/2"	22	16
D8073	90 x 3"	22	16
D8074	90 x 4"	16	15
D8075	110 x 2"	12	8
D8076	110 x 2 1/2"	12	8
D8077	110 x 3"	12	8
D8078	110 x 4"	12	8

PN16

**Male Adaptor**

Муфта с наружной резьбой

رأس خط سن خارجي

Adaptador con Rosca Externa  
Adaptador com Rosca Externa

CODE	DIMENSIONS (mm)	BOX UNIT (NB)	SACK/BAG (NB)
D8201	20 x 20	300	250
D8202	25 x 25	200	160
D8203	32 x 32	125	100
D8204	40 x 40	85	65
D8205	50 x 50	56	36
D8206	63 x 63	33	23
D8207	75 x 75	22	16
D8208	90 x 90	12	9
D8209	110 x 110	8	5

PN16

## Intermediate Union (Coupling)

Муфта соединительная  
وصلة  
Manchon  
Conexión de Compresión  
Conexão de Compressão



CODE	DIMENSIONS (mm)	BOX UNIT (NB)	SACK/BAG (NB)
D8150	20 x 20 x 20	175	140
D8151	25 x 25 x 25	100	80
D8152	32 x 32 x 32	60	50
D8153	40 x 40 x 40	40	30
D8154	50 x 50 x 50	30	20
D8155	63 x 63 x 63	18	12
D8156	75 x 75 x 75	10	9
D8157	90 x 90 x 90	5	5
D8158	110 x 110 x 110	3	2

PN16

## Equal Tee

Тройник соединительный  
تي  
Te Égal  
Tee 90° Compresión  
Tè 90° Compressão



CODE	DIMENSIONS (mm)	BOX UNIT (NB)	SACK/BAG (NB)
D8250	20 x 20	300	250
D8251	25 x 25	175	140
D8252	32 x 32	120	90
D8253	40 x 40	65	50
D8254	50 x 50	40	30
D8255	63 x 63	25	20
D8256	75 x 75	15	14
D8257	90 x 90	9	8
D8258	110 x 110	5	4

PN16

## Equal Elbow

Отвод соединительный  
كوع  
Coude Égal  
Codo de 90°  
Joelho 90°



CODE	DIMENSIONS (mm)	BOX UNIT (NB)	SACK/BAG (NB)
D8600	20	450	360
D8601	25	300	240
D8602	32	200	160
D8603	40	150	110
D8604	50	90	70
D8605	63	55	45
D8606	75	45	30
D8607	90	24	16
D8608	110	12	10

PN16

## End Cap

Заглушка

طبة

Bouchon

Tampón de Compresión  
Tampão de Compressão



CODE	DIMENSIONS (mm)	BOX UNIT (NB)	SACK/BAG (NB)
D8300	25 x 20	210	175
D8301	32 x 20	150	120
D8302	32 x 25	150	120
D8303	40 x 20	105	90
D8304	40 x 25	105	80
D8305	40 x 32	105	80
D8306	50 x 25	65	50
D8307	50 x 32	65	50
D8308	50 x 40	65	50
D8309	63 x 25	55	40
D8310	63 x 32	55	40
D8311	63 x 40	48	30
D8312	63 x 50	40	30
D8313	75 x 50	30	20
D8314	75 x 63	23	20
D8315	90 x 63	15	12
D8316	90 x 75	15	12
D8317	110 x 63	8	7
D8318	110 x 75	8	5
D8319	110 x 90	8	5

PN16

## Reduced Union

Муфта редуцирующая

جلبة مسلوقة

Manchon Réduit

Unión de Compresión de Reducción  
União de Compressão de Redução



CODE	DIMENSIONS (mm)	BOX UNIT (NB)	SACK/BAG (NB)
D8350	25 x 20 x 25	100	80
D8351	32 x 20 x 32	75	60
D8352	32 x 25 x 32	75	60
D8352-1	40 x 20 x 40	50	35
D8353	40 x 25 x 40	50	35
D8354	40 x 32 x 40	50	35
D8355	50 x 25 x 50	36	25
D8356	50 x 32 x 50	36	25
A8357	50 x 40 x 50	30	22
D8358	63 x 25 x 63	20	13
D8359	63 x 32 x 63	18	13
D8360	63 x 40 x 63	18	13
D8361	63 x 50 x 63	18	13
D8362	75 x 50 x 75	13	9
D8363	75 x 63 x 75	13	9
D8364	90 x 63 x 90	7	5
DD8365	90 x 75 x 90	7	5
D8366	110 x 63 x 110	4	3
D8367	110 x 75 x 110	4	3
D8368	110 x 90 x 110	4	3

PN16

## Reduced Tee

Тройник редуцирующий

تي مسلوقة

Te Réduit

Tee Compresión de Reducción  
Têe de Compressão de Redução



CODE	DIMENSIONS (mm)	BOX UNIT (NB)	SACK/BAG (NB)
D8400	20 x 1/2"	500	400
D8401	20 x 3/4"	500	400
D8402	25x 1/2"	300	240
D8403	25 x 3/4"	300	240
D8403-1	25 x 1"	250	200
D8404	32 x 3/4"	175	140
D8405	32 x 1"	175	140
D8406	40 x 1"	110	80
D8407	40 x 1 1/4"	110	80
D8408	50 x 1 1/4"	75	45
D8409	50 x 1 1/2"	75	45
D8410	50 x 2"	70	45
D8411	63 x 1 1/2"	45	33
D8412	63 x 2"	40	33
D8413	75 x 2"	28	20
D8414	75 x 2 1/2"	28	20
D8415	90 x 2 1/2"	15	10
D8416	90 x 3"	15	10
D8417	110 x 3"	9	7
D8418	110 x 4"	9	7

PN16

## Female Elbow

Отвод с внутренней резьбой  
 كوع ضغط سن داخلي  
 Coude Femelle  
 Codo 90° con Rosca Interna  
 Joelha 90° com Rosca Interna



CODE	DIMENSIONS (mm)	BOX UNIT (NB)	SACK/BAG (NB)
D8450	20 x 1/2"	500	400
D8451	20 x 3/4"	500	400
D8452	25 x 1/2"	250	200
D8453	25 x 3/4"	250	200
D8454	25 x 1"	250	200
D8455	32 x 3/4"	175	140
D8456	32 x 1"	175	140
D8457	32 x 1 1/4"	150	120
D8458	40 x 1"	100	70
D8459	40 x 1 1/4"	100	70
D8460	40 x 1 1/2"	90	70
D8461	50 x 1 1/4"	75	50
D8462	50 x 1 1/2"	75	50
D8463	50 x 2"	70	45
D8464	63 x 1 1/2"	45	35
D8465	63 x 2"	45	35
D8466	63 x 2 1/2"	40	30
D8467	75 x 2"	28	22
D8468	75 x 2 1/2"	28	22
D8469	75 x 3"	25	20
D8470	90 x 2 1/2"	15	13
D8471	90 x 3"	15	13
D8472	110 x 3"	9	7
D8473	110 x 4"	9	7

PN16

## Male Elbow

Отвод с наружной резьбой  
 كوع ضغط سن خارجي  
 Coude Mâle  
 Codo 90° con Rosca Externa  
 Joelha 90° com Rosca Externa



CODE	DIMENSIONS (mm)	BOX UNIT (NB)	SACK/BAG (NB)
D8500	20 x 1/2" x 20	250	200
D8501	20 x 3/4" x 20	250	200
D8502	25 x 1/2" x 25	150	120
D8503	25 x 3/4" x 25	150	120
D8503-1	25 x 1" x 25	125	100
D8504	32 x 1/2" x 32	100	80
D8505	32 x 3/4" x 32	100	80
D8506	32 x 1" x 32	100	80
D8507	40 x 3/4" x 40	60	40
D8508	40 x 1" x 40	60	40
D8509	40 x 1 1/4" x 40	60	40
D8510	50 x 1" x 50	40	25
D8511	50 x 1 1/4" x 50	40	25
D8512	50 x 1 1/2" x 50	40	25
D8512-1	63 x 1 x 63	24	15
D8513	63 x 1 1/4" x 63	24	15
D8514	63 x 1 1/2" x 63	24	15
D8515	63 x 2" x 63	24	15
D8516	75 x 2" x 75	16	11
D8517	75 x 2 1/2" x 75	16	11
D8518	90 x 2 1/2" x 90	8	6
D8519	90 x 3" x 90	8	6
D8520	110 x 3" x 110	5	3
D8521	110 x 4" x 110	5	3

PN16

## Female Tee

Тройник с внутренней резьбой  
تي ضغط سن داخلي  
Te Femelle  
Tee 90° con Rosca Interna  
Tê 90° com Rosca Interna



CODE	DIMENSIONS (mm)	BOX UNIT (NB)	SACK/BAG (NB)
D8050	20 x 1/2"	720	540
D8051	20 x 3/4"	450	360
D8052	25 x 1/2"	375	300
D8053	25 x 3/4"	375	300
D8054	25 x 1"	300	240
D8055	32x 1/2"	250	200
D8056	32 x 3/4"	250	200
D8057	32 x 1"	250	200
D8058	32 x 1 1/4"	200	160
D8059-1	40 x 3/4"	140	100
D8059	40 x 1"	140	100
D8060	40 x 1 1/4"	140	100
D8061	40 x 1 1/2"	130	90
D8062-1	50 x 1"	100	70
D8062	50 x 1 1/4"	100	70
D8063	50 x 1 1/2"	90	70
D8064	50x2"	80	65
D8065	63 x 1 1/2"	56	43
D8066	63 x 2"	56	43
D8067	63 x 2 1/2"	50	40
D8068	75x2"	38	27
D8069	75 x 2 1/2"	38	27
D8070	75x3"	30	25
D8071	90x2"	22	16
D8072	90 x 2 1/2"	22	16
D8073	90 x 3"	22	16
D8074	90 x 4"	16	15
D8075	110 x 2"	12	8
D8076	110 x 2 1/2"	12	8
D8077	110 x 3"	12	8
D8078	110 x 4"	12	8

PN16

## Male Tee

Тройнике с наружной резьбой  
تي ضغط سن خارجي  
Te Mâle  
Tee 90° con Rosca Externa  
Tê 90° com Rosca Externa



CODE	DIMENSIONS (mm)	BOX UNIT (NB)	SACK/BAG (NB)
A8650	25 x 20	200	120
D8651	32 x 25	120	90
D8652	40 x 32	65	50
D8653	50 x 40	40	30
D8654	63 x 50	28	20
D8655	75 x 63	20	14
D8656	90 x 75	10	8
D8657	110 x 75	5	4
D8658	110 x 90	5	4

PN16

## Reduced Elbow

Редукционный отвод

كوع مسلوب

Coude Réduit

Codo 90° Compresión de Reducción

Joelho 90° Compressão de Redução



CODE	DIMENSIONS (mm)	BOX UNIT (NB)
DB080	1/2" x 1/2"	380
DB081	3/4" x 3/4"	270
DB082	1" x 1"	190
DB083	1 1/4" x 1 1/4"	120
DB084	1 1/2" x 1 1/2"	75
DB085	2" x 2"	45
DB086	2 1/2" x 2 1/2"	23
DB087	3" x 3"	13
DB088	4" x 4"	8

## PP Compression Male Female Connecting Valve

Mâle - femelle vanne de connection

Кран шаровой с наружной и внутренней резьбой

Válvula de Esfera Macho e Fêmea

Valvula con Esfera Macho y Hembra

محبس سن داخلي-سن خارجي

PN16



CODE	DIMENSIONS (mm)	BOX UNIT (NB)
DB070	20 x 20	210
DB071	25 x 25	130
DB072	32 x 32	95
DB073	40 x 40	55
DB074	50 x 50	32
DB075	63 x 63	20
DB076	75 x 75	14
DB077	90 x 90	7
DB078	110 x 110	5

CODE	DIMENSIONS (mm)	BOX UNIT (NB)
DB010	20 x 1/2"	280
DB011	25 x 3/4"	180
DB012	32 x 1"	130
DB013	40 x 1 1/4"	80
DB014	50 x 1 1/2"	45
DB015	63 x 2"	25
DB016	75 x 2 1/2"	17
DB017	90 x 3"	10
DB018	110 x 4"	5

## PP Compression Equal Valve

PN16

PP Соединяющий шаровый кран  
محبس كورة بولي برويلين بمخرج  
Válvula de compresión  
Válvula de Compressão  
PP ventil sa metal  
PP valvola me rrethe metali



## PP Compression Female Valve

PN16

Шаровой кран с внутренней резьбой  
محبس سن داخلي  
Vanne Femelle De Compression En PP





CODE	DIMENSIONS (mm)	BOX UNIT (NB)
DB019	20 x 1/2"	280
DB020	25 x 3/4"	175
DB021	32 x 1"	125
DB022	40 x 1 1/4"	75
DB023	50 x 1 1/2"	45
DB024	63 x 2"	25
DB025	75 x 2 1/2"	17
DB026	90 x 3"	11
DB027	110 x 4"	6

PN16

## PP Compression Male Valve

Шаровой кран с наружной резьбой

محبس سن خارجي

Vanne Mâle de compression En pp

Válvula de Compresión Macho PP



CODE	DIMENSIONS (mm)	BOX UNIT (NB)
DB060	1/2" x 1/2"	400
DB061	3/4" x 3/4"	270
DB062	1" x 1"	190
DB063	1 1/4" x 1 1/4"	125
DB064	1 1/2" x 1 1/2"	75
DB065	2" x 2"	45
DB066	2 1/2" x 2 1/2"	26
DB067	3" x 3"	15
DB068	4" x 4"	8

PN16

## PP Compression Connecting Valve With Plastic Ball

Соединяющий шаровой кран с пластмассовым клапаном

وصلة محبس لي بي بكرة بلاستيك

Vanne Avec Boule En Plastique En PP

Válvula Esfera de plástico en PP



CODE	DIMENSIONS (mm)	BOX UNIT (NB)	SACK/BAG (NB)
D8709	40 x 1"	120	100
D8710	40 x 1¼"	120	100
D8711	40 x 1½"	110	90
D8712	50 x 1¼"	80	60
D8713	50 x 1½"	80	60
D8714	50 x 2"	70	55
D8715	63 x 1½"	60	40
D8716	63 x 2"	60	40
D8717	63 x 2½"	50	35
D8718	75 x 2"	40	26
D8719	75 x 2½"	40	26
D8720	75 x 3"	30	23
D8721	90 x 2"	24	16
D8722	90 x 2½"	24	16
D8723	90 x 3"	24	16
D8724	90 x 4"	20	15
D8725	110 x 2"	12	8
D8726	110 x 2½"	12	8
D8727	110 x 3"	12	8
D8728	110 x 4"	12	8

PN16

### Female Adaptor With Stainless Chrome Ring

Муфта с железном кольцом ( в.р )  
 بداية خط سن داخلي معادن غير قابل للصدأ  
 Raccord Femelle avec anneau en Chrome inoxydable  
 Adaptador Hembra Con Anillo De Cromo Inoxidable  
 Adaptador Fêmea Com Anel Cromado Inoxidável



CODE	DIMENSIONS (mm)	BOX UNIT (NB)	SACK/BAG (NB)
D8800	40 x 1½"	40	24
D8801	50 x 1½"	30	20
D8802	50 x 2"	30	20
D8803	63 x 2"	22	14
D8804	63 x 2½"	22	13
D8805	75 x 2½"	14	10
D8806	75 x 3"	14	8
D8807	90 x 3"	9	6
D8808	90 x 4"	9	6
D8809	110 x 4"	8	6

PN16

### PP Compression Flanged Adaptor

Муфта фланцева  
 فلاتسا  
 Raccord Avec Bride  
 Adaptador de compresión con brida  
 Adaptador de compressão com flange



CODE	DIMENSIONS (mm)	BOX UNIT (NB)
G001	20 x 1/2"	400
D002	25 x 3/4"	240
D002-1	25 x 1"	200
D002-2	32 x 3/4"	160
D003	32 x 1"	160
D004	40 x 1 1/4"	100
D005	50 x 1 1/2"	60
D006	63 x 2"	40
D007	75 x 2 1/2"	26
D008	90 x 3"	16
D009	110 x 4"	8

PN16

## Female Brass Threaded Adaptor

Муфта с металлической внутренней резьбой

خط سن داخلي معدن أصلي

Raccord Femelle Avec Métal Original

Adaptador Hembra Reforzada

Adaptador Fêmea Reforçada



CODE	DIMENSIONS (mm)	BOX UNIT (NB)
D010	20 x 1/2"	360
D011	25 x 3/4"	225
D011-1	25 x 1"	225
D011-2	32 x 3/4"	200
D012	32 x 1"	200
D013	40 x 1 1/4"	100
D014	50 x 1 1/2"	70
D015	63 x 2"	43
D016	75 x 2 1/2"	27
D017	90 x 3"	16
D018	110 x 4"	8

PN16

## Male Brass Threaded Adaptor

Муфта с металлической наружной резьбой

خط سن خارجي معدن أصلي

Raccord Mâle avec Métal original

Adaptador Macho Reforzada

Adaptador Macho Reforçada



## Clamp Saddle with Lock Type Gasket

Седловая врезка

سادل مع طوق مغلق

Collier de Prise en Charge Avec Joint Verrouillé

Collar de Toma con Sello Cerrado

Collar de Tomada com Selo Trancado



PN16

CODE	DIMENSIONS (mm)	BOX UNIT (NB)	SACK/BAG (NB)
DC000	25 x 1/2"	500	400
DC000-1	25 x 3/4"	500	400
DC001	32 x 1/2"	300	270
DC002	32 x 3/4"	300	270
DC003	32 x 1"	300	270
DC004	40 x 1/2"	300	220
DC005	40 x 3/4"	300	220
DC006	40 x 1"	250	200
DC007	50 x 1/2"	120	85
DC008	50 x 3/4"	120	85
DC009	50 x 1"	120	85
DC010	50 x 1 1/4"	110	80
DC011	50 x 1 1/2"	110	80
DC012	63 x 1/2"	90	70
DC013	63 x 3/4"	90	70
DC014	63 x 1"	90	70
DC015	63 x 1 1/4"	80	65
DC016	63 x 1 1/2"	80	65
DC016-1	63 x 2"	80	65
DC017	75 x 1/2"	100	80
DC018	75 x 3/4"	100	80
DC019	75 x 1"	100	80
DC020	75 x 1 1/4"	80	60
DC021	75 x 1 1/2"	80	60
DC021-1	75 x 2"	80	60
DC022	90 x 1/2"	80	60
DC023	90 x 3/4"	80	60
DC024	90 x 1"	80	60
DC025	90 x 1 1/4"	64	48
DC026	90 x 1 1/2"	64	48
DC027	90 x 2"	64	48
DC028	110 x 1/2"	60	40
DC029	110 x 3/4"	60	40
DC030	110 x 1"	60	40
DC031	110 x 1 1/4"	60	40
DC032	110 x 1 1/2"	60	40

CODE	DIMENSIONS (mm)	BOX UNIT (NB)	SACK/BAG (NB)
DC033	110 x 2"	50	40
DC034	110 x 2 1/2"	25	20
DC035	110 x 3"	25	20
DC036	125 x 1/2"	60	40
DC037	125 x 3/4"	60	40
DC038	125 x 1"	60	40
DC039	125 x 1 1/4"	50	32
DC040	125 x 1 1/2"	50	32
DC041	125 x 2"	50	32
DC042	140 x 1/2"	40	20
DC043	140 x 3/4"	40	20
DC044	140 x 1"	40	20
DC045	140 x 1 1/4"	40	20
DC046	140 x 1 1/2"	40	20
DC047	140 x 2"	40	20
DC048	160 x 1/2"	24	18
DC049	160 x 3/4"	24	18
DC050	160 x 1"	24	18
DC051	160 x 1 1/4"	24	18
DC052	160 x 1 1/2"	24	18
DC053	160 x 2"	24	18
DC054	160 x 2 1/2"	12	10
DC055	160 x 3"	12	10
DC057	200 x 1"	9	7
DC058	200 x 1 1/4"	9	7
DC059	200 x 1 1/2"	9	7
C060	200 x 2"	9	7
DC061	225 x 1"	9	6
DC062	225 x 1 1/4"	9	6
DC063	225 x 1 1/2"	9	6
DC064	225 x 2"	9	6
DC065	250 x 1"	6	5
DC066	250 x 1 1/4"	6	5
DC067	250 x 1 1/2"	6	5
DC068	250 x 2"	6	5

## Clamp Saddle Double Ended with Lock Type Gasket

2 storonnyaya sedlovaya vrezka

سادل ثنائي المخرج مع طوق مغلق

Collar De Toma Con Salida

Doble Y Sello Cerrado

Colar De Toma Com Saída

Dupla E Selo Trancado



PN16

CODE	DIMENSIONS (mm)	BOX UNIT (NB)	SACK/BAG (NB)
D098	25 x 1/2" x 1/2"	450	350
D099	25 x 3/4" x 3/4"	450	350
D100	32 x 1/2" x 1/2"	325	200
D101	32 x 3/4" x 3/4"	325	200
D102	32 x 1" x 1"	325	200
D103	40 x 1/2" x 1/2"	250	125
D104	40 x 3/4" x 3/4"	250	125
D105	40 x 1" x 1"	250	125
D106	50 x 1/2" x 1/2"	100	50
D107	50 x 3/4" x 3/4"	100	50
D108	50 x 1" x 1"	100	50
D109	50 x 1 1/4" x 1 1/4"	90	45
D110	50 x 1 1/2" x 1 1/2"	90	45
D111	63 x 1/2" x 1/2"	80	35
D112	63 x 3/4" x 3/4"	80	35
D113	63 x 1" x 1"	80	35
D114	63 x 1 1/4" x 1 1/4"	70	30
D115	63 x 1 1/2" x 1 1/2"	70	30
D115-1	63 x 2" x 2"	70	30
D116	75 x 1/2" x 1/2"	70	30
D117	75 x 3/4" x 3/4"	70	30
D118	75 x 1" x 1"	70	30
D119	75 x 1 1/4" x 1 1/4"	70	35
D120	75 x 1 1/2" x 1 1/2"	70	35
D120-1	75 x 2" x 2"	70	35
D121	90 x 1/2" x 1/2"	60	24
D122	90 x 3/4" x 3/4"	60	24
D123	90 x 1" x 1"	60	24
D124	90 x 1 1/4" x 1 1/4"	55	24
D125	90 x 1 1/2" x 1 1/2"	55	24

CODE	DIMENSIONS (mm)	BOX UNIT (NB)	SACK/BAG (NB)
D126	90 x 2" x 2"	50	24
D127	110 x 1/2" x 1/2"	50	18
D128	110 x 3/4" x 3/4"	50	18
D129	110 x 1" x 1"	50	18
D130	110 x 1 1/4" x 1 1/4"	50	18
D131	110 x 1 1/2" x 1 1/2"	50	18
D132	110 x 2" x 2"	50	18
D133	110 x 2 1/2" x 2 1/2"	40	15
D134	110 x 3" x 3"	40	15
D135	125 x 1/2" x 1/2"	50	10
D136	125 x 3/4" x 3/4"	50	8
D137	125 x 1" x 1"	50	8
D138	125 x 1 1/4" x 1 1/4"	50	8
D139	125 x 1 1/2" x 1 1/2"	50	8
D140	125 x 2" x 2"	50	8
D141	140 x 1/2" x 1/2"	40	10
D142	140 x 3/4" x 3/4"	40	10
D143	140 x 1" x 1"	40	10
D144	140 x 1 1/4" x 1 1/4"	40	10
D145	140 x 1 1/2" x 1 1/2"	40	10
D146	140 x 2" x 2"	40	10
D147	160 x 1/2" x 1/2"	25	8
D148	160 x 3/4" x 3/4"	25	8
D149	160 x 1" x 1"	25	8
D150	160 x 1 1/4" x 1 1/4"	25	8
D151	160 x 1 1/2" x 1 1/2"	25	8
D152	160 x 2" x 2"	25	8
D153	160 x 2 1/2" x 2 1/2"	20	8
D154	160 x 3" x 3"	20	8

## Clamp Saddle With Brass Threaded and Lock Type Gasket

Металлическая седловая врезка

سادل معدن أصلي مع طوق مغلق

Collar De Toma Reforzada Con Sello Cerrado

Colar De Tomada Reforçada Com Selo Trancado



PN16



CODE	DIMENSIONS (mm)	BOX UNIT (NB)	SACK/BAG (NB)
D300	50 x 1/2"	120	85
D301	50 x 3/4"	120	85
D302	50 x 1"	120	85
D303	63 x 1/2"	90	70
D304	63 x 3/4"	90	70
D305	63 x 1"	90	70
D306	75 x 1/2"	100	80
D307	75 x 3/4"	100	80
D308	75 x 1"	100	80
D309	90 x 1/2"	80	60
D310	90 x 3/4"	80	60
D311	90 x 1"	80	60
D311-1	90 x 1 1/4"	64	60
D311-2	90 x 1 1/2"	64	60
D311-3	90 x 2"	64	48
D312	110 x 1/2"	60	40
D313	110 x 3/4"	60	40
D314	110 x 1"	60	40
D314-1	110 x 1 1/4"	60	40
D314-2	110 x 1 1/2"	60	40
D314-3	110 x 2"	50	40
D315	125 x 1/2"	60	40
D316	125 x 3/4"	60	40
D317	125 x 1"	60	40
D318	125 x 1 1/4"	50	32
D319	125 x 1 1/2"	50	32
D320	125 x 2"	50	32
D321	140 x 1/2"	40	20
D322	140 x 3/4"	40	20
D323	140 x 1"	40	20
D324	140 x 1 1/4"	40	20
D325	140 x 1 1/2"	40	20
D326	140 x 2"	40	20
D327	160 x 1/2"	24	18

CODE	DIMENSIONS (mm)	BOX UNIT (NB)	SACK/BAG (NB)
D328	160 x 3/4"	24	18
D329	160 x 1"	24	18
D330	160 x 1 1/4"	24	18
D331	160 x 1 1/2"	24	18
D332	160 x 2"	24	18
D332-1	160 x 2 1/2"	12	10
D332-2	160 x 3"	12	10
D332-3	160 x 4"	12	10
D333	200 x 1"	9	7
D334	200 x 1 1/4"	9	7
D335	200 x 1 1/2"	9	7
D336	200 x 2"	9	7
D337	200 x 2 1/2"	9	7
D338	200 x 3"	9	7
D339	200 x 4"	9	7
D340	225 x 1"	9	6
D341	225 x 1 1/4"	9	6
D342	225 x 1 1/2"	9	6
D343	225 x 2"	9	6
D344	225 x 2 1/2"	9	6
D345	225 x 3"	9	6
D346	225 x 4"	9	6
D347	250 x 1"	6	5
D348	250 x 1 1/4"	6	5
D349	250 x 1 1/2"	6	5
D350	250 x 2"	6	5
D351	250 x 2 1/2"	6	5
D352	250 x 3"	6	5
D353	250 x 4"	6	5
D354	315 x 1"	4	3
D355	315 x 1 1/4"	4	3
D356	315 x 1 1/2"	4	3
D357	315 x 2"	4	3
D358	315 x 2 1/2"	4	3
D359	315 x 3"	4	3
D360	315 x 4"	4	3

CODE	DIMENSIONS (mm)	BOX UNIT (NB)	SACK/BAG (NB)
D200	32 x 1/2"	350	300
D201	32 x 3/4"	350	300
D202	40 x 1/2"	300	250
D203	40 x 3/4"	300	250
D204	50 x 1/2"	130	110
D205	50 x 3/4"	130	110
D206	50 x 1"	130	110
D207	63 x 1/2"	110	95
D208	63 x 3/4"	110	95
D209	63 x 1"	110	95
D210	75 x 1/2"	90	70
D211	75 x 3/4"	90	70
D212	75 x 1"	90	70
D213	90x1/2"	70	65
D214	90x3/4"	70	65
D214-1	90x1"	70	65
D215	110x1/2"	55	45
D216	110x3/4"	55	45
D217	110x1"	55	45

CODE	DIMENSIONS (mm)	BOX UNIT (NB)	SACK/BAG (NB)
D250	32 x 1/2" x 1/2"	270	250
D251	32 x 3/4" x 3/4"	270	250
D252	40 x 1/2" x 1/2"	250	230
D253	40 x 3/4" x 3/4"	250	230
D254	50 x 1/2" x 1/2"	110	95
D255	50 x 3/4" x 3/4"	110	95
D256	50 x 1" x 1"	110	95
D257	63 x 1/2" x 1/2"	95	80
D258	63 x 3/4" x 3/4"	95	80
D259	63 x 1" x 1"	95	80
D260	75 x 1/2" x 1/2"	80	65
D261	75 x 3/4" x 3/4"	80	65
D262	75 x 1" x 1"	80	65
D263	90 x 1/2" x 1/2"	60	50
D264	90 x 3/4" x 3/4"	60	50
D265	90 x 1" x 1"	60	50
D266	110 x 1/2" x 1/2"	55	45
D267	110 x 3/4" x 3/4"	55	45
D268	110 x 1" x 1"	55	45

### Clamp Saddle Locked Slide Type

Зажимное седло тип скользящего  
سائل منزلق معلق

Collar de toma con traba deslizante  
Colar de tomada com trava tipo deslizante



### Clamp Saddle Double Ended Locked Slide Type

Зажимное седло двухстороннее скользящего типа  
سائل ثنائي المخرج منزلق معلق

Collar de toma con traba deslizante double salida  
Colar de tomada com trava tipo deslizante saida dupla



## DATKA VALVE BOX

Box with  
Valve 3/4"

DIMENSIONS (mm)	IN PALLET (Pcs)	UNIT WEIGHT (Kg)
18 x 18 x 12	480	0,615

\*\* Pallet Size  
120 x 130 x 210 cm



Round  
Valve Box 6"

DIMENSIONS (mm)	IN PALLET (Pcs)	UNIT WEIGHT (Kg)
16,4 x 23,7 x 6	500	0,645

\*\* Pallet Size  
110 x 120 x 180 cm



Round  
Valve Box 10"

DIMENSIONS (mm)	IN PALLET (Pcs)	UNIT WEIGHT (Kg)
24,6 x 25 x 10	300	1,400

\*\* Pallet Size  
110 x 120 x 200 cm



Standard  
Valve Box 12"

DIMENSIONS (mm)	IN PALLET (Pcs)	UNIT WEIGHT (Kg)
26,8 x 39,4 x 30,8	150	4,000

\*\* Pallet Size  
110 x 120 x 200 cm



Standard Valve  
Box Locked 12"

DIMENSIONS (mm)	IN PALLET (Pcs)	UNIT WEIGHT (Kg)
26,8 x 39,4 x 30,8	150	4,000

\*\* Pallet Size  
110 x 120 x 200 cm



Standard Valve  
Box Hinged 12"

DIMENSIONS (mm)	IN PALLET (Pcs)	UNIT WEIGHT (Kg)
26,8 x 39,4 x 30,8	150	4,000

\*\* Pallet Size  
110 x 120 x 200 cm



Jumbo  
Valve Box 14"

DIMENSIONS (mm)	IN PALLET (Pcs)	UNIT WEIGHT (Kg)
48 x 63 x 30,5	100	6,100

\*\* Pallet Size  
110 x 120 x 200 cm





## FLAT DRIP IRRIGATION SYSTEMS



0,15 (mm) / Ø 17 (mm)

6 mil

CODE	CODE	DRIPPER	MT / ROLL
1,6 Lt / H	2,2 Lt / H	DISTANCE (cm)	
250-15001	250-15002	20	1800
250-15041	250-15042	25	2000
250-15003	250-15004	30	2000
250-15005	250-15006	40	2000
250-15007	250-15008	50	2000

0,20 (mm) / Ø 17 (mm)

8 mil

CODE	CODE	DRIPPER	MT / ROLL
1,6 Lt / H	2,2 Lt / H	DISTANCE (cm)	
250-15009	250-15010	20	2300
250-15044	250-15043	25	2300
250-15011	250-15012	30	2300
250-15013	250-15014	40	2300
250-15015	250-15016	50	2300

0,25 (mm) / Ø 17 (mm)

10 mil

CODE	CODE	DRIPPER	MT / ROLL
1,6 Lt / H	2,2 Lt / H	DISTANCE (cm)	
250-15017	250-15018	20	1700
250-15045	250-15046	25	1800
250-15019	250-15020	30	1800
250-15021	250-15022	40	1800
250-15023	250-15024	50	1800

0,30 (mm) / Ø 17 (mm)

12 mil

CODE	CODE	DRIPPER	MT / ROLL
1,6 Lt / H	2,2 Lt / H	DISTANCE (cm)	
250-15025	250-15026	20	1700
250-15047	250-15048	25	1800
250-15027	250-15028	30	1800
250-15029	250-15030	40	1800
250-15031	250-15032	50	1800

## FLAT DRIP IRRIGATION SYSTEMS



0,40 (mm) / Ø 17 (mm)

18 mil

CODE	CODE	DRIPPER DISTANCE (cm)	MT / ROLL
1,6 Lt / H	2,2 Lt / H		
250-15033	250-15034	20	1300
250-15049	250-15050	25	1400
250-15035	250-15036	30	1400
250-15037	250-15038	40	1400
250-15039	250-15040	50	1400

0,20 (mm) / Ø 22 (mm)

8 mil

CODE	CODE	DRIPPER DISTANCE (cm)	MT / ROLL
1,6 Lt / H	2,2 Lt / H		
250-16001	250-16002	20	1700
250-16033	250-16034	25	1800
250-16003	250-16004	30	1800
250-16005	250-16006	40	1800
250-16007	250-16008	50	1800

0,25 (mm) / Ø 22 (mm)

10 mil

CODE	CODE	DRIPPER DISTANCE (cm)	MT / ROLL
1,6 Lt / H	2,2 Lt / H		
250-16009	250-16010	20	1300
250-16035	250-16036	25	1400
250-16011	250-16012	30	1400
250-16013	250-16014	40	1400
250-16015	250-16016	50	1400

0,30 (mm) / Ø 22 (mm)

12 mil

CODE	CODE	DRIPPER DISTANCE (cm)	MT / ROLL
1,6 Lt / H	2,2 Lt / H		
250-16017	250-16018	20	1000
250-16037	250-16038	25	1100
250-16019	250-16020	30	1100
250-16021	250-16022	40	1100
250-16023	250-16024	50	1100

0,40 (mm) / Ø 22 (mm)

18 mil

CODE	CODE	DRIPPER DISTANCE (cm)	MT / ROLL
1,6 Lt / H	2,2 Lt / H		
250-16025	250-16026	20	700
250-16039	250-16040	25	800
250-16027	250-16028	30	800
250-16029	250-16030	40	800
250-16031	250-16032	50	800

## IRRIGATION PIPES

### 16 mm Round Drip Irrigation Pipes



CODE	DIAMETER (Ø)	THICKNESS (mm)	RANGE (cm)	LENGTH	FLOW
042218	16	0,9	20	400	2-4-8
042219	16	0,9	25	400	2-4-8
042220	16	0,9	33	400	2-4-8
042221	16	0,9	40	400	2-4-8
042222	16	0,9	50	400	2-4-8
042223	16	0,9	60	400	2-4-8
042224	16	0,9	70	400	2-4-8
042225	16	0,9	75	400	2-4-8
042226	16	0,9	80	400	2-4-8
042227	16	0,9	90	400	2-4-8
042228	16	0,9	100	400	2-4-8

### 16 mm Round Drip Irrigation Pipes



CODE	DIAMETER (Ø)	THICKNESS (mm)	RANGE (cm)	LENGTH	FLOW
042229	16	1,0	20	400	2-4-8
042230	16	1,0	25	400	2-4-8
042231	16	1,0	33	400	2-4-8
042232	16	1,0	40	400	2-4-8
042233	16	1,0	50	400	2-4-8
042234	16	1,0	60	400	2-4-8
042235	16	1,0	70	400	2-4-8
042236	16	1,0	75	400	2-4-8
042237	16	1,0	80	400	2-4-8
042238	16	1,0	90	400	2-4-8
042239	16	1,0	100	400	2-4-8

## IRRIGATION PIPES

### 20 mm Round Drip Irrigation Pipes



CODE	DIAMETER (Ø)	THICKNESS (mm)	RANGE (cm)	LENGTH	FLOW
042240	20	1,1	20	300	2-4-8
042241	20	1,1	25	300	2-4-8
042242	20	1,1	33	300	2-4-8
042243	20	1,1	40	300	2-4-8
042244	20	1,1	50	300	2-4-8
042245	20	1,1	60	300	2-4-8
042246	20	1,1	70	300	2-4-8
042247	20	1,1	75	300	2-4-8
042248	20	1,1	80	300	2-4-8
042249	20	1,1	90	300	2-4-8
042250	20	1,1	100	300	2-4-8

### Straight Drip Irrigation Pipes



CODE	DIAMETER (Ø)	THICKNESS (mm)	LENGTH
042251	16	0,9	400
042252	16	1,0	400
042331	16	1,1	400
042253	20	1,0	300
042254	20	1,2	300
042332	20	1,5	300
042255	25	1,2	200
042256	25	1,5	200
042333	25	2,0	200

**Mini Valve Barbed**



Code	Dimensions	Pcs/Box	Box Size
SD042500	16x16	400	42*33*26
SD042501	20x16	350	42*33*26
SD042502	20x20	350	42*33*26

**Mini Valve Barbed Offtake**



Code	Dimensions	Pcs/Box	Box Size
SD042503	16x16	400	
SD042504	20x20	350	

**Mini Valve Thread Male - Barbed**



Code	Dimensions	Pcs/Box	Box Size
SD042505	16x1/2"	400	
SD042506	16x3/4"	350	
SD042507	20x1/2"	300	
SD042508	20x3/4"	300	

**Mini Valve Barbed For Tape & GR**



Code	Dimensions	Pcs/Box	Box Size
SD042509	17x16	300	300

**Mini Valve Thread Male - Tape & GR**



Code	Dimensions	Pcs/Box	Box Size
SD042510	17x1/2"	300	
SD042511	17x3/4"	275	

**Mini Valve Offtake For Tape & GR**



Code	Dimensions	Pcs/Box	Box Size
SD042512	17x16	300	300

**Mini Valve Barbed With Ring**



Code	Dimensions	Pcs/Box	Box Size
SD042513	17x16	300	300

**Mini Valve Offtake With Ring**



Code	Dimensions	Pcs/Box	Box Size
SD042514	17x16	300	300

**Mini Valve Thread Male - With Ring**



Code	Dimensions	Pcs/Box	Box Size
SD042515	17x1/2"	300	42*33*26
SD042516	17x3/4"	275	42*33*26

**Mini Valve Layflat For Tape & GR**



Code	Dimensions	Pcs/Box	Box Size
SD042516-1	17	-	40*32*26

**Mini Valve Layflat With Ring**



Code	Dimensions	Pcs/Box	Box Size
SD042516-2	17	-	40*32*26

**Mini Valve Layflat Barbed**



Code	Dimensions	Pcs/Box	Box Size
SD042516-3	16	-	40*32*26

### Mini Valve Barbed



Code	Dimensions	Pcs/Box	Box Size
SD042001	16x16	350	42*32*26
SD042002	20x16	350	42*32*26
SD042003	20x20	300	42*32*26
SD042004	25x25	150	42*32*26

### Mini Valve Thread Male - Barbed



Code	Dimensions	Pcs/Box	Box Size
SD042008	16x1/2"	350	42*32*26
SD042009	16x3/4"	350	42*32*26
SD042010	20x1/2"	350	42*32*26
SD042011	20x3/4"	300	42*32*26
SD042012	25x1/2"	150	42*32*26
SD042013	25x3/4"	150	42*32*26

### Mini Valve Tape



Code	Dimensions	Pcs/Box	Box Size
SD042018	17x17	250	42*32*26
SD042019	20x20	200	42*32*26
SD042020	25x25	125	42*32*26

### Mini Valve Thread Male - Tape



Code	Dimensions	Pcs/Box	Box Size
SD042021	17x1/2"	300	42*32*26
SD042022	17x3/4"	275	42*32*26
SD042023	20x1/2"	250	42*32*26
SD042024	20x3/4"	250	42*32*26
SD042025	22x1/2"	250	42*32*26
SD042026	22x3/4"	250	42*32*26
SD042027	25x1/2"	150	42*32*26
SD042028	25x3/4"	150	42*32*26

### Mini Valve Barbed With Ring



Code	Dimensions	Pcs/Box	Box Size
SD042029	17x16	350	42*32*26
SD042030	22x20	250	42*32*26
SD042031	25x20	175	42*32*26

### Mini Valve Ring



Code	Dimensions	Pcs/Box	Box Size
SD042041	17x17	350	42*32*26
SD042042	22x22	250	42*32*26
SD042043	25x25	150	42*32*26

### Mini Valve Barbed Offtake



Code	Dimensions	Pcs/Box	Box Size
SD042005	16x16	350	42*32*26
SD042005-1	20x16	350	42*32*26
SD042006	20x20	300	42*32*26
SD042007	25x20	150	42*32*26

### Mini Valve Offtake For Tape



Code	Dimensions	Pcs/Box	Box Size
SD042014	17x16	300	42*32*26
SD042015	20x20	250	42*32*26
SD042016	22x20	250	42*32*26
SD042017	25x20	150	42*32*26

### Mini Valve Barbed For Tape



Code	Dimensions	Pcs/Box	Box Size
SD042014-1	17x16	300	42*32*26
SD042015-1	20x20	250	42*32*26
SD042016-1	22x20	250	42*32*26
SD042017-1	25x20	150	42*32*26

### Mini Valve Thread Male - With Ring



Code	Dimensions	Pcs/Box	Box Size
SD042035	17x1/2"	300	42*32*26
SD042036	17x3/4"	275	42*32*26
SD042037	22x1/2"	250	42*32*26
SD042038	22x3/4"	250	42*32*26
SD042039	25x1/2"	150	42*32*26
SD042040	25x3/4"	150	42*32*26

### Mini Valve Offtake With Ring



Code	Dimensions	Pcs/Box	Box Size
SD042032	17x16	350	42*32*26
SD042033	22x20	250	42*32*26
SD042034	25x20	175	42*32*26

### Mini Valve Layflat Tape



Code	Dimensions	Pcs/Box	Box Size
SD042043-1	17	-	42*32*26

**Mini Valve Three Way  
Male - With Ring**



Code	Dimensions	Pcs/Box	Box Size
Sd042044	17x1/2"x17	175	42*32*26
Sd042045	22x1/2"x22	150	42*32*26

**Mini Valve Three Way  
Male - For Tape**



Code	Dimensions	Pcs/Box	Box Size
Sd042046	17x1/2"x17	175	42*32*26
Sd042047	22x1/2"x22	150	42*32*26

**Mini Valve Three Way  
Offtake - With Ring**



Code	Dimensions	Pcs/Box	Box Size
Sd042261	17x20x17	175	42*32*26
Sd042262	22x20x22	125	42*32*26

**Mini Valve Three Way  
Offtake - For Tape**



Code	Dimensions	Pcs/Box	Box Size
Sd042263	17x20x17	150	42*32*26
Sd042264	22x20x22	125	42*32*26

**Mini Valve Three Way  
Offtake - Barbed**



Code	Dimensions	Pcs/Box	Box Size
Sd042263-1	16x20x16	200	42*32*26
Sd042263-2	20x20x20	175	42*32*26

**Mini Valve Three Way  
Barbed**



Code	Dimensions	Pcs/Box	Box Size
SD042263-3	16x16x16	200	42*32*26
SD042263-4	20x16x20	175	42*32*26
SD042263-5	20x20x20	175	42*32*26

**Mini Valve Elbow  
Male - With Ring**



Code	Dimensions	Pcs/Box	Box Size
SD042048	17x1/2"	150	42*32*26
SD042049	22x1/2"	150	42*32*26

**Mini Valve Elbow  
Male - For Tape**



Code	Dimensions	Pcs/Box	Box Size
SD042050	17x1/2"	200	42*32*26
SD042051	22x1/2"	175	42*32*26

**Mini Valve Elbow  
Offtake - For Tape**



Code	Dimensions	Pcs/Box	Box Size
SD042265	17x20	175	42*32*26
SD042266	22x20	150	42*32*26

**Mini Valve Elbow  
Offtake - With Ring**



Code	Dimensions	Pcs/Box	Box Size
SD042267	17x20	175	42*32*26
SD042268	22x20	150	42*32*26

### Mini Valve Barbed



Code	Dimensions	Pcs/Box	Box Size
SD042089	16x16	350	42*32*26

### Mini Valve Barbed Offtake



Code	Dimensions	Pcs/Box	Box Size
SD042090	16x16	350	42*32*26

### Mini Valve Offtake For Tape



Code	Dimensions	Pcs/Box	Box Size
SD042091	17x16	300	42*32*26

### Mini Valve Offtake With Ring



Code	Dimensions	Pcs/Box	Box Size
SD042092	17x16	300	42*32*26

### Mini Valve For Tape



Code	Dimensions	Pcs/Box	Box Size
SD042093-1	17x16	300	42*32*26

### Mini Valve With Ring



Code	Dimensions	Pcs/Box	Box Size
Sd042093	17x16	300	42*32*26

### Barbed Nipple



Code	Dimensions	Pcs/Box	Size
SD042094	16x16	2000	70*40*15
SD042096	20x20	1000	70*40*15

### Barbed Reduction



Code	Dimensions	Pcs/Box	Size
SD042095	20x16	1000	70*40*15

### Barbed With Gasket Nipple



Code	Dimensions	Pcs/Box	Size
SD042097	16x16	2000	70*40*15
SD042098	20x20	1000	70*40*15

### Barbed Plug



Code	Dimensions	Pcs/Box	Size
SD042099	16 mm	2000	70*40*15
SD042100	20 mm	1000	70*40*15

### End Clamp Ring



Code	Dimensions	Pcs/Box	Size
SD042101	16 mm	2500	70*40*15
SD042102	20 mm	1500	70*40*15

### Barbed Tee



Code	Dimensions	Pcs/Box	Size
SD042103	16x16x16	1000	70*40*15
SD042104	16x20x16	1000	70*40*15
SD042105	20x16x20	750	70*40*15
SD042106	20x20x20	500	70*40*15

### Barbed Elbow



Code	Dimensions	Pcs/Box	Size
SD042107	16x16	1500	70*40*15
SD042108	20x20	1000	70*40*15

### Spike



Code	Dimensions	Pcs/Box	Size
SD042114	Long	300	70*40*15
SD042115	Short	300	70*40*15



### **Tape (With Ring) Nipple**



Code	Dimensions	Pcs/Box	Box Size
SD042052	17x17	1000	42*33*26
SD042053	22x22	500	42*33*26
SD042054	25x25	400	42*33*26

### **Tape & GR Nipple**



Code	Dimensions	Pcs/Box	Box Size
SD042067	17x17	600	42*33*26
SD042068	22x22	300	42*33*26
SD042069	25x25	300	42*33*26

### **Tape & GR Offtake Nipple**



Code	Dimensions	Pcs/Box	Box Size
SD042070	17x16	800	42*33*26
SD042071	22x20	400	42*33*26
SD042072	25x20	400	42*33*26

### **Tape (With Ring) Grommet Tee**



Code	Dimensions	Pcs/Box	Box Size
SD042061	17x16x17	250	42*33*26
SD042058	17x20x17	250	42*33*26
SD042062	22x20x22	200	42*33*26
SD042063	25x20x25	200	42*33*26

### **Tape (With Ring) Male Tee**



Code	Dimensions	Pcs/Box	Box Size
SD042064	17x1/2"x17	250	42*33*26
SD042065	22x1/2"x22	200	42*33*26
SD042066	25x1/2"x25	200	42*33*26

### **Dripline Tee**



Code	Dimensions	Pcs/Box	Box Size
SD042077	20x20x20	150	42*33*26
SD042078	22x22x22	150	42*33*26
SD042079	25x25x25	150	42*33*26

### **Tape (With Ring) Offtake**



Code	Dimensions	Pcs/Box	Box Size
SD042055	17x16	1000	42*33*26
SD042056	22x20	500	42*33*26
SD042057	25x20	400	42*33*26

### **Tape (With Ring) Barbed**



Code	Dimensions	Pcs/Box	Box Size
SD042055-1	17x16	1000	42*33*26
SD042056-1	22x20	500	42*33*26
SD042057-1	25x20	400	42*33*26

### **Tape & GR Male Nipple**



Code	Dimensions	Pcs/Box	Box Size
SD042073	22x1/2	500	42*33*26
SD042074	22x3/4	500	42*33*26
SD042075	25x1/2	500	42*33*26
SD042076	25x3/4	500	42*33*26

### **Dripline Grommet Tee**



Code	Dimensions	Pcs/Box	Box Size
SD042080	17x16x17	250	42*33*26
SD042080-1	17x20x17	250	42*33*26
SD042080-2	20x20x20	200	42*33*26
SD042081	22x20x22	200	42*33*26
SD042082	25x20x25	200	42*33*26

### **Dripline Male Tee**



Code	Dimensions	Pcs/Box	Box Size
SD042083	17x1/2"x17	250	42*33*26
SD042084	22x1/2"x22	200	42*33*26
SD042085	25x1/2"x25	200	42*33*26

### **Dripline -Male Elbow**



Code	Dimensions	Pcs/Box	Box Size
SD042086	17x1/2"	300	42*33*26
SD042087	22x1/2"	250	42*33*26
SD042088	25x1/2"	250	42*33*26

### Barbed Grommet Gasket



Code	Dimensions	Pcs/Box	Box Size
SD042111	16 mm	3000	42*33*26
SD042112	20 mm	2000	42*33*26
SD042112-1	8 mm	5000	42*33*26

### Barbed Grommet Gasket



Code	Dimensions	Pcs/Box	Box Size
SD042113	16 mm	3000	42*33*26
SD042260	20 mm	2000	42*33*26

### Barbed Grommet End Cap Gasket



Code	Dimensions	Pcs/Box	Box Size
SD042258	16 mm	3000	42*33*26
SD042259	20 mm	2000	42*33*26

### PC Emitter



Code	Dimensions	Pcs/Box	Box Size
SD042110-1	2 L/h	2500	42*33*26
SD042110-2	4 L/h	2500	42*33*26
SD042110-3	8 L/h	2500	42*33*26
SD042110-4	16 L/h	2500	42*33*26

### Green On-Line Dripper



Code	Dimensions	Pcs/Box	Box Size
SD042109	0-100 L/h	2000	42*33*26

### Red On-Line Dripper



Code	Dimensions	Pcs/Box	Box Size
SD042110	0-70 L/h	5000	42*33*26

### 3 mm Manuel Driller



Code	Dimensions	Pcs/Box	Box Size
SD042116	3 mm	50	42*33*26

### Manuel Driller



Code	Dimensions	Pcs/Box	Box Size
SD042117	16 mm	50	42*33*26
SD042118	20 mm	50	42*33*26

### Driller



Code	Dimensions	Pcs/Box	Box Size
SD042119	16 mm	100	42*33*26
SD042120	20 mm	100	42*33*26

Flow Rate	0.5 bar	1 bar	2 bar	3 bar	4 bar
2 L/h	1.9	2	2	2.1	2.2
4 L/h	3.8	4	4	4.2	4.3
8 L/h	7.7	8	8	8.1	8.3
16 L/h	15.8	16	16	16.2	16.4

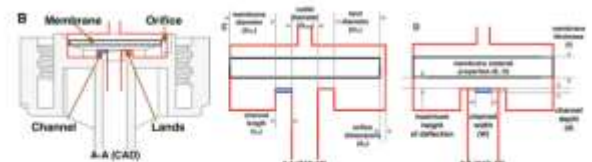

### Black On-Line Dripper



Code	Dimensions	Pcs/Box	Box Size
SD042257	0-150 L/h	2000	42*33*26

### Radius Stable Mini Sprayer



Code	Dimensions	Pcs/Box	Box Size
SD042400	180°	500	42*33*26
SD042401	360°	500	42*33*26

**Emitter Four Way Manifold**



Code	Dimensions	Pcs/Box	Box Size
MT042001	5 mm	-	42*33*26

**Emitter Tee Manifold**



Code	Dimensions	Pcs/Box	Box Size
MT042002	5 mm	-	42*33*26

**Emitter Elbow Manifold**



Code	Dimensions	Pcs/Box	Box Size
MT042003	5 mm	-	42*33*26

**Hydroponic Stake**



Code	Dimensions	Pcs/Box	Box Size
MT042008	5 mm	-	42*33*26
MT042009	5 mm	-	42*33*26

**Microtube Pipe (Spaghetti)**



Code	Dimensions	Pcs/Box	Box Size
SPG042001	5 mm	-	-
SPG042002	7 mm	-	-

**Radius Stable Mini Sprayer Set**



Code	Dimensions	Pcs/Box	Box Size
SD042400-1	180°	500	42*33*26
SD042401-1	360°	500	42*33*26

**Emitter Outlet Connector**



Code	Dimensions	Pcs/Box	Box Size
MT042004	5 mm	-	42*33*26

**Plug For Microtube**



Code	Dimensions	Pcs/Box	Box Size
MT042005	7 mm	-	42*33*26

**Coupling For Microtube**



Code	Dimensions	Pcs/Box	Box Size
MT042006	5 mm	-	42*33*26
MT042007	7 mm	-	42*33*26

**Starter Outlet Microtube**



Code	Dimensions	Pcs/Box	Box Size
MT042010	-	-	42*33*26

**PC Emitter Stake Set 1-2-3-4 Way**



Code	Dimensions	Pcs/Box	Box Size
SD042110-5	2 L/h ■	500	42*33*26
SD042110-6	4 L/h ■	500	42*33*26
SD042110-7	8 L/h ■	500	42*33*26
SD042110-8	16 L/h ■	500	42*33*26





Code	Dimensions	Pcs/Box	Box Size
SD042130	1/2"	250	26*41*41
SD042131	3/4"	150	26*41*41
SD042132	1"	90	26*41*41
SD042133	1 1/4"	60	26*41*41
SD042134	1 1/2"	50	26*41*41
SD042135	2"	30	26*41*41
SD042136	2 1/2"	14	26*41*41
SD042137	3"	8	26*41*41
SD042138	4"	4	26*41*41



### PP Ball Valve

Code	Dimensions	Pcs/Box	Box Size
SD042134-1	1 1/2"	50	26*41*41
SD042135-1	2"	30	26*41*41
SD042136-1	2 1/2"	14	26*41*41
SD042137-1	3"	8	26*41*41
SD042138-1	4"	4	26*41*41



### PP Ball Valve With Steel Bar

Code	Dimensions	Pcs/Box	Box Size
SD042130-1	1/2"	250	26*41*41
SD042131-1	3/4"	150	26*41*41
SD042132-1	1"	90	26*41*41
SD042133-1	1 1/4"	60	26*41*41
SD042134-2	1 1/2"	50	26*41*41
SD042135-2	2"	30	26*41*41
SD042136-2	2 1/2"	14	26*41*41
SD042137-2	3"	8	26*41*41
SD042138-2	4"	4	26*41*41

### Pipe Distributor



Code	Dimensions	Pcs/Box	Box Size
SD042140	32 x32x20	100	42*33*26
SD042141	32x32x25	100	42*33*26

### Stake Fixing



Code	Dimensions	Pcs/Box	Box Size
SD042143	1/2x20	400	42*33*26
SD042144	1/2x25	300	42*33*26

### Pipe Distributor



Code	Dimensions	Pcs/Box	Box Size
SD042142	32 x25x20	100	42*33*26

### Stake Fixing



Code	Dimensions	Pcs/Box	Box Size
SD042145	1/2x1/2	500	42*33*26

### Pipe Distributor



Code	Dimensions	Pcs/Box	Box Size
SD042139	32x20	100	42*33*26

### Reduction



Code	Dimensions	Pcs/Box	Box Size
SD042154	32x20	200	42*33*26
SD042155	32x25	200	42*33*26
SD042155-1	32x32	200	42*33*26

## DATA SHEET

<b>DESCRIPTION</b>	LAY FLAT
<b>PRODUCT NAME</b>	MANYAS L
<b>MATERIAL</b>	POLYVINYLCHLORIDE

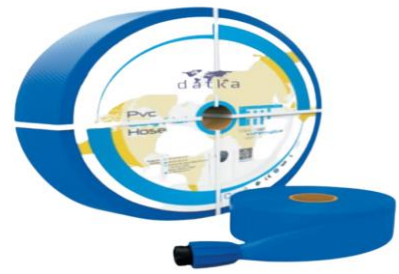

### Features

By combining mono layered polyester yarn and plastic material via using high technology, Manyas lay flat hoses are made of PVC-NBR material which is reinforced by resistant polyester yarn.

### Application

Suitable for use in drip irrigation systems and water transfer.

CODE	INCH (mm)	INSIDE DIA. (mm)	WORK PRESSURE (BAR)	BURST PRESSURE (BAR)	WEIGHT gr/mt	LENGTH (MT)
M.L.025.050 & M.L.025.100	1"	25	6	18	165	50/100
M.L.030.050 & M.L.030.100		30	6	18	190	50/100
M.L.032.050 & M.L.032.100	1.1/4"	32	6	18	200	50/100
M.L.038.050 & M.L.038.100	1.1/2"	38	6	18	210	50/100
M.L.040.050 & M.L.040.100		40	6	18	240	50/100
M.L.052.050 & M.L.052.100	2"	52	6	18	310	50/100
M.L.063.050 & M.L.063.100	2.1/2"	63	6	18	365	50/100
M.L.077.050 & M.L.077.100	3"	77	6	18	450	50/100
M.L.090.050 & M.L.090.100		90	6	18	560	50/100
M.L.102.050 & M.L.102.100	4"	102	6	18	650	50/100

-30 °C / +60 °C	STANDARD	COLOR
 -22 °F / +140 °F	ISO 1307	DARK BLUE

## DATA SHEET

<b>DESCRIPTION</b>	LAY FLAT
<b>PRODUCT NAME</b>	MANYAS SL
<b>MATERIAL</b>	POLYVINYLCHLORIDE



### Features

By combining mono layered polyester yarn and plastic material via using high technology, Manyas lay flat hoses are made of PVC-NBR material which is reinforced by resistant polyester yarn.

### Application

Suitable for use in drip irrigation systems and water transfer.

CODE	INCH (mm)	INSIDE DIA. (mm)	WORK PRESSURE (BAR)	BURST PRESSURE (BAR)	WEIGHT gr/mt	LENGTH (MT)
M.SL.038.050 & M.SL.038.100	1 1/2"	38	3	9	185	50/100
M.SL.040.050 & M.SL.040.100		40	3	9	200	50/100
M.SL.052.050 & M.SL.052.100	2"	52	3	9	250	50/100
M.SL.060.050 & M.SL.060.100		60	3	9	280	50/100
M.SL.063.050 & M.SL.063.100	2 1/2"	63	3	9	300	50/100
M.SL.077.050 & M.SL.077.100	3"	77	3	9	380	50/100
M.SL.102.050 & M.SL.102.100	4"	102	3	9	450	50/100

	-30 °C / +60 °C	STANDARD	COLOR
 -22 °F / +140 °F		ISO 1307	LIGHT BLUE

## DATA SHEET

<b>DESCRIPTION</b>	LAY FLAT
<b>PRODUCT NAME</b>	MANYAS M
<b>MATERIAL</b>	POLYVINYLCHLORIDE



### Features

By combining mono layered polyester yarn and plastic material via using high technology, Manyas lay flat hoses are made of PVC-NBR material which is reinforced by resistant polyester yarn.

### Application

Suitable for use in drip irrigation systems and water transfer.

CODE	INCH (mm)	INSID E DIA. (mm)	WOR K PRESSU RE (BAR)	BURS T PRESSU RE (BAR)	WEIG HT gr/mt	LENG TH (MT )
M.M.025.050 & M.M.025.100	1"	2 5	10	3 0	185	50/1 00
M.M.030.050 & M.M.030.100		3 0	10		210	50/1 00
M.M.032.050 & M.M.032.100	1 1/4	3 2	10	3 0	225	50/1 00
M.M.038.050 & M.M.038.100	1 1/2	3 8	10		270	50/1 00
M.M.040.050 & M.M.040.100		4 0	10	3 0	300	50/1 00
M.M.052.050 & M.M.052.100	2"	5 2	10		340	50/1 00
M.M.063.050 & M.M.063.100	2 1/2	6 3	10	3 0	420	50/1 00
M.M.077.050 & M.M.077.100	3"	7 7	10		670	50/1 00
M.M.090.050 & M.M.090.100		9 0	10	3 0	870	50/1 00
M.M.102.050 & M.M.102.100	4"	1 0 2	10	3 0	950	50/1 00

	-30 °C / +60 °C	STANDARD	COLOR
	-22 °F / +140 °F	ISO 1307	GREEN

# PPRC Ball Valves with **ABS\*** Ball



SIZE	PN
DN 20	PN20
DN 25	PN20
DN 32	PN20
DN 40	PN20
DN 50	PN20
DN 63	PN20
DN 75	PN16
DN 90	PN16
DN 110	PN16

**ABS** stands for **Acrylonitrile Butadiene Styrene**. **ABS** is an impact-resistant engineering thermoplastic & amorphous polymer. **ABS** is made up of three monomers: **acrylonitrile, butadiene and styrene**:

**Acrylonitrile**: It is a synthetic monomer produced from propylene and ammonia. This component contributes to ABS chemical resistance & heat stability.

**Butadiene**: It is produced as a by-product of ethylene production from steam crackers. This component delivers toughness & impact strength to ABS polymer.

**Styrene**: It is manufactured by dehydrogenation of ethyl benzene. It provides rigidity & processability to ABS plastic.



## İKİZ PLASTİK DİSK FİLTRELER / DOUBLE PLASTIC DISC FILTERS

■ 130 micron / 120 mesh  
Bağlantı Tipi • Connection Type



V: Viktolik • Victaulic

T: Dişli • Threaded  
BSPT | NPT



Bağlantı Çapı Connection Diameter	Ürün Kodu Product Code	Bağlantı Tipi Connection Type	Cinsi Type	Kapasite Capacity	Filtrasyon Yüzeyi Filtration Surface	Koli Tipi Box Type
inch				m <sup>3</sup> /h	cm <sup>2</sup>	
3"	960-030-01-01	BSPT x BSPT	Kısa Short	70	2670	B-4
	960-030-01-11	NPT x NPT				
	960-030-01-02	V x V				
	960-030-02-01	BSPT x BSPT	Uzun Long	100	3615	B-5
	960-030-02-11	NPT x NPT				
	960-030-02-02	V x V				
4"	960-040-01-01	BSPT x BSPT	Kısa Short	70	2670	B-4
	960-040-01-11	NPT x NPT				
	960-040-01-02	V x V				
	960-040-02-01	BSPT x BSPT	Uzun Long	100	3615	B-5
	960-040-02-11	NPT x NPT				
	960-040-02-02	V x V				

## İKİZ PLASTİK ELEK FİLTRELER / DOUBLE PLASTIC SCREEN FILTERS

■ 530 micron / 35 mesh  
■ 200 micron / 75 mesh  
■ 130 micron / 120 mesh  
■ 100 micron / 150 mesh

Bağlantı Tipi • Connection Type



V: Viktolik • Victaulic

T: Dişli • Threaded  
BSPT | NPT



Bağlantı Çapı Connection Diameter	Ürün Kodu Product Code	Bağlantı Tipi Connection Type	Cinsi Type	Kapasite Capacity	Filtrasyon Yüzeyi Filtration Surface	Koli Tipi Box Type
inch				m <sup>3</sup> /h	cm <sup>2</sup>	
3"	960-030-01-03	BSPT x BSPT	Kısa Short	70	2435	B-4
	960-030-01-13	NPT x NPT				
	960-030-01-04	V x V				
	960-030-02-03	BSPT x BSPT	Uzun Long	100	3245	B-5
	960-030-02-13	NPT x NPT				
	960-030-02-04	V x V				
4"	960-040-01-03	BSPT x BSPT	Kısa Short	70	2435	B-4
	960-040-01-13	NPT x NPT				
	960-040-01-04	V x V				
	960-040-02-03	BSPT x BSPT	Uzun Long	100	3245	B-5
	960-040-02-13	NPT x NPT				
	960-040-02-04	V x V				

Filtre kelepçeleri mühendislik plastiğinden üretilmiştir.  
Filter clamps are produced of engineering plastic.

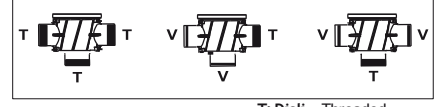
TEKLİ PLASTİK DİSK FİLTRELER /  
SINGLE PLASTIC DISC FILTERS130 micron / 120 mesh  
Bağlantı Tipi • Connection Type

V: Viktolik • Victaulic

T: Dişli • Threaded  
BSPT | NPT

Bağlantı Çapı Connection Diameter	Ürün Kodu Product Code	Bağlantı Tipi Connection Type	Cinsi Type	Kapasite Capacity	Filtrasyon Yüzeyi Filtration Surface	Koli Tipi Box Type	
inch				m <sup>3</sup> /h	cm <sup>2</sup>		
2"	910-020-01-01	BSPT x BSPT x BSPT	Kısa Short	40	1335	B-3	
	910-020-01-11	NPT x NPT x NPT					
	910-020-01-02	V x V x BSPT					
	910-020-01-12	V x V x NPT					
	910-020-01-03	V x BSPT x V					
	910-020-01-13	V x NPT x V					
	910-020-02-01	BSPT x BSPT x BSPT	Uzun Long	40	1810	B-3	
	910-020-02-11	NPT x NPT x NPT					
	910-020-02-02	V x V x BSPT					
	910-020-02-12	V x V x NPT					
	910-020-02-03	V x BSPT x V					
	910-020-02-13	V x NPT x V					
	2 ½"	910-025-01-01	BSPT x BSPT x BSPT	Kısa Short	48	1335	B-3
		910-025-01-11	NPT x NPT x NPT				
910-025-01-02		V x V x BSPT					
910-025-01-12		V x V x NPT					
910-025-01-03		V x BSPT x V					
910-025-01-13		V x NPT x V					
910-025-02-01		BSPT x BSPT x BSPT	Uzun Long	48	1810	B-3	
910-025-02-11		NPT x NPT x NPT					
910-025-02-02		V x V x BSPT					
910-025-02-12		V x V x NPT					
910-025-02-03		V x BSPT x V					
910-025-02-13		V x NPT x V					
3"		910-030-01-01	BSPT x BSPT x BSPT	Kısa Short	55	1335	B-3
		910-030-01-11	NPT x NPT x NPT				
	910-030-01-02	V x V x BSPT					
	910-030-01-12	V x V x NPT					
	910-030-01-03	V x BSPT x V					
	910-030-01-13	V x NPT x V					
	910-030-02-01	BSPT x BSPT x BSPT	Uzun Long	55	1810	B-3	
	910-030-02-11	NPT x NPT x NPT					
	910-030-02-02	V x V x BSPT					
	910-030-02-12	V x V x NPT					
	910-030-02-03	V x BSPT x V					
	910-030-02-13	V x NPT x V					

Filtre kelepçeleri mühendislik plastiğinden üretilmiştir.  
Filter clamps are produced of engineering plastic.

TEKLİ PLASTİK ELEK FİLTRELER /  
SINGLE PLASTIC SCREEN FILTERS

■ 530 micron / 35 mesh      130 micron / 120 mesh ■  
■ 200 micron / 75 mesh      100 micron / 150 mesh ■

Bağlantı Tipi • Connection Type

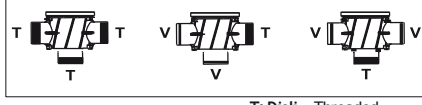

V: Viktolik • Victaulic

T: Dişli • Threaded  
BSPT | NPT

Bağlantı Çapı Connection Diameter	Ürün Kodu Product Code	Bağlantı Tipi Connection Type	Cinsi Type	Kapasite Capacity	Filtrasyon Yüzeyi Filtration Surface	Koli Tipi Box Type
inch				m <sup>3</sup> /h	cm <sup>2</sup>	
2"	910-020-01-04	BSPT x BSPT x BSPT	Kısa Short	40	1210	B-3
	910-020-01-14	NPT x NPT x NPT				
	910-020-01-05	V x V x BSPT				
	910-020-01-15	V x V x NPT				
	910-020-01-06	V x BSPT x V				
	910-020-01-16	V x NPT x V				
	910-020-02-04	BSPT x BSPT x BSPT	Uzun Long	40	1620	B-3
	910-020-02-14	NPT x NPT x NPT				
	910-020-02-05	V x V x BSPT				
	910-020-02-15	V x V x NPT				
	910-020-02-06	V x BSPT x V				
	910-020-02-16	V x NPT x V				
2 ½"	910-025-01-04	BSPT x BSPT x BSPT	Kısa Short	48	1210	B-3
	910-025-01-14	NPT x NPT x NPT				
	910-025-01-05	V x V x BSPT				
	910-025-01-15	V x V x NPT				
	910-025-01-06	V x BSPT x V				
	910-025-01-16	V x NPT x V				
	910-025-02-04	BSPT x BSPT x BSPT	Uzun Long	48	1620	B-3
	910-025-02-14	NPT x NPT x NPT				
	910-025-02-05	V x V x BSPT				
	910-025-02-15	V x V x NPT				
	910-025-02-06	V x BSPT x V				
	910-025-02-16	V x NPT x V				
3"	910-030-01-04	BSPT x BSPT x BSPT	Kısa Short	55	1210	B-3
	910-030-01-14	NPT x NPT x NPT				
	910-030-01-05	V x V x BSPT				
	910-030-01-15	V x V x NPT				
	910-030-01-06	V x BSPT x V				
	910-030-01-16	V x NPT x V				
	910-030-02-04	BSPT x BSPT x BSPT	Uzun Long	55	1620	B-3
	910-030-02-14	NPT x NPT x NPT				
	910-030-02-05	V x V x BSPT				
	910-030-02-15	V x V x NPT				
	910-030-02-06	V x BSPT x V				
	910-030-02-16	V x NPT x V				

Filtre kelepçeleri mühendislik plastiğinden üretilmiştir.  
Filter clamps are produced of engineering plastic.

İKİZ PLASTİK DİSK FİLTRELER /  
DOUBLE PLASTIC DISC FILTERS130 micron / 120 mesh ■  
Bağlantı Tipi • Connection Type

V: Viktolik • Victaulic

T: Dişli • Threaded  
BSPT | NPT

Bağlantı Çapı Connection Diameter	Ürün Kodu Product Code	Bağlantı Tipi Connection Type	Cinsi Type	Kapasite Capacity	Filtrasyon Yüzeyi Filtration Surface	Koli Tipi Box Type
inch				m <sup>3</sup> /h	cm <sup>2</sup>	
3"	950-030-01-01	BSPT x BSPT	Kısa Short	70	2670	B-4
	950-030-01-11	NPT x NPT				
	950-030-01-02	V x V				
	950-030-02-01	BSPT x BSPT	Uzun Long	100	3615	B-5
	950-030-02-11	NPT x NPT				
	950-030-02-02	V x V				
4"	950-040-01-01	BSPT x BSPT	Kısa Short	70	2670	B-4
	950-040-01-11	NPT x NPT				
	950-040-01-02	V x V				
	950-040-02-01	BSPT x BSPT	Uzun Long	100	3615	B-5
	950-040-02-11	NPT x NPT				
	950-040-02-02	V x V				

İKİZ PLASTİK ELEK FİLTRELER /  
DOUBLE PLASTIC SCREEN FILTERS

■ 530 micron / 35 mesh      130 micron / 120 mesh ■  
■ 200 micron / 75 mesh      100 micron / 150 mesh ■

Bağlantı Tipi • Connection Type



V: Viktolik • Victaulic

T: Dişli • Threaded  
BSPT | NPT

Bağlantı Çapı Connection Diameter	Ürün Kodu Product Code	Bağlantı Tipi Connection Type	Cinsi Type	Kapasite Capacity	Filtrasyon Yüzeyi Filtration Surface	Koli Tipi Box Type
inch				m <sup>3</sup> /h	cm <sup>2</sup>	
3"	950-030-01-03	BSPT x BSPT	Kısa Short	70	2435	B-4
	950-030-01-13	NPT x NPT				
	950-030-01-04	V x V				
	950-030-02-03	BSPT x BSPT	Uzun Long	100	3245	B-5
	950-030-02-13	NPT x NPT				
	950-030-02-04	V x V				
4"	950-040-01-03	BSPT x BSPT	Kısa Short	70	2435	B-4
	950-040-01-13	NPT x NPT				
	950-040-01-04	V x V				
	950-040-02-03	BSPT x BSPT	Uzun Long	100	3245	B-5
	950-040-02-13	NPT x NPT				
	950-040-02-04	V x V				

Filtre kelepçeleri paslanmaz çelikten üretilmiştir.  
Filter clamps are produced of stainless steel.

## TEKLİ PLASTİK DİSK FİLTRELER / SINGLE PLASTIC DISC FILTERS

■ 130 micron / 120 mesh  
Bağlantı Tipi • Connection Type

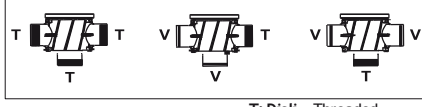

V: Viktolik • Victaulic

T: Dişli • Threaded  
BSPT | NPT



Bağlantı Çapı Connection Diameter	Ürün Kodu Product Code	Bağlantı Tipi Connection Type	Cinsi Type	Kapasite Capacity	Filtrasyon Yüzeyi Filtration Surface	Koli Tipi Box Type
inch				m <sup>3</sup> /h	cm <sup>2</sup>	
2"	900-020-01-01	BSPT x BSPT x BSPT	Kısa Short	40	1335	B-3
	900-020-01-11	NPT x NPT x NPT				
	900-020-01-02	V x V x BSPT				
	900-020-01-12	V x V x NPT				
	900-020-01-03	V x BSPT x V				
	900-020-01-13	V x NPT x V				
	900-020-02-01	BSPT x BSPT x BSPT	Uzun Long	40	1810	B-3
	900-020-02-11	NPT x NPT x NPT				
	900-020-02-02	V x V x BSPT				
	900-020-02-12	V x V x NPT				
900-020-02-03	V x BSPT x V					
900-020-02-13	V x NPT x V					
2 ½"	900-025-01-01	BSPT x BSPT x BSPT	Kısa Short	48	1335	B-3
	900-025-01-11	NPT x NPT x NPT				
	900-025-01-02	V x V x BSPT				
	900-025-01-12	V x V x NPT				
	900-025-01-03	V x BSPT x V				
	900-025-01-13	V x NPT x V				
	900-025-02-01	BSPT x BSPT x BSPT	Uzun Long	48	1810	B-3
	900-025-02-11	NPT x NPT x NPT				
	900-025-02-02	V x V x BSPT				
	900-025-02-12	V x V x NPT				
900-025-02-03	V x BSPT x V					
900-025-02-13	V x NPT x V					
3"	900-030-01-01	BSPT x BSPT x BSPT	Kısa Short	55	1335	B-3
	900-030-01-11	NPT x NPT x NPT				
	900-030-01-02	V x V x BSPT				
	900-030-01-12	V x V x NPT				
	900-030-01-03	V x BSPT x V				
	900-030-01-13	V x NPT x V				
	900-030-02-01	BSPT x BSPT x BSPT	Uzun Long	55	1810	B-3
	900-030-02-11	NPT x NPT x NPT				
	900-030-02-02	V x V x BSPT				
	900-030-02-12	V x V x NPT				
900-030-02-03	V x BSPT x V					
900-030-02-13	V x NPT x V					

Filtre kelepçeleri paslanmaz çelikten üretilmiştir.  
Filter clamps are produced of stainless steel.

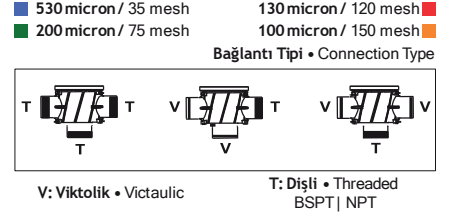
TEKLİ PLASTİK ELEK FİLTRELER /  
SINGLE PLASTIC SCREEN FILTERS

Bağlantı Çapı Connection Diameter	Ürün Kodu Product Code	Bağlantı Tipi Connection Type	Cinsi Type	Kapasite Capacity	Filtrasyon Yüzeyi Filtration Surface	Koli Tipi Box Type
inch				m <sup>3</sup> /h	cm <sup>2</sup>	
2"	900-020-01-04	BSPT x BSPT x BSPT	Kısa Short	40	1210	B-3
	900-020-01-14	NPT x NPT x NPT				
	900-020-01-05	V x V x BSPT				
	900-020-01-15	V x V x NPT				
	900-020-01-06	V x BSPT x V				
	900-020-01-16	V x NPT x V				
	900-020-02-04	BSPT x BSPT x BSPT	Uzun Long	40	1620	B-3
	900-020-02-14	NPT x NPT x NPT				
	900-020-02-05	V x V x BSPT				
	900-020-02-15	V x V x NPT				
900-020-02-06	V x BSPT x V					
900-020-02-16	V x NPT x V					
2 ½"	900-025-01-04	BSPT x BSPT x BSPT	Kısa Short	48	1210	B-3
	900-025-01-14	NPT x NPT x NPT				
	900-025-01-05	V x V x BSPT				
	900-025-01-15	V x V x NPT				
	900-025-01-06	V x BSPT x V				
	900-025-01-16	V x NPT x V				
	900-025-02-04	BSPT x BSPT x BSPT	Uzun Long	48	1620	B-3
	900-025-02-14	NPT x NPT x NPT				
	900-025-02-05	V x V x BSPT				
	900-025-02-15	V x V x NPT				
900-025-02-06	V x BSPT x V					
900-025-02-16	V x NPT x V					
3"	900-030-01-04	BSPT x BSPT x BSPT	Kısa Short	55	1210	B-3
	900-030-01-14	NPT x NPT x NPT				
	900-030-01-05	V x V x BSPT				
	900-030-01-15	V x V x NPT				
	900-030-01-06	V x BSPT x V				
	900-030-01-16	V x NPT x V				
	900-030-02-04	BSPT x BSPT x BSPT	Uzun Long	55	1620	B-3
	900-030-02-14	NPT x NPT x NPT				
	900-030-02-05	V x V x BSPT				
	900-030-02-15	V x V x NPT				
900-030-02-06	V x BSPT x V					
900-030-02-16	V x NPT x V					

Filtre kelepçeleri paslanmaz çelikten üretilmiştir.  
Filter clamps are produced of stainless steel.

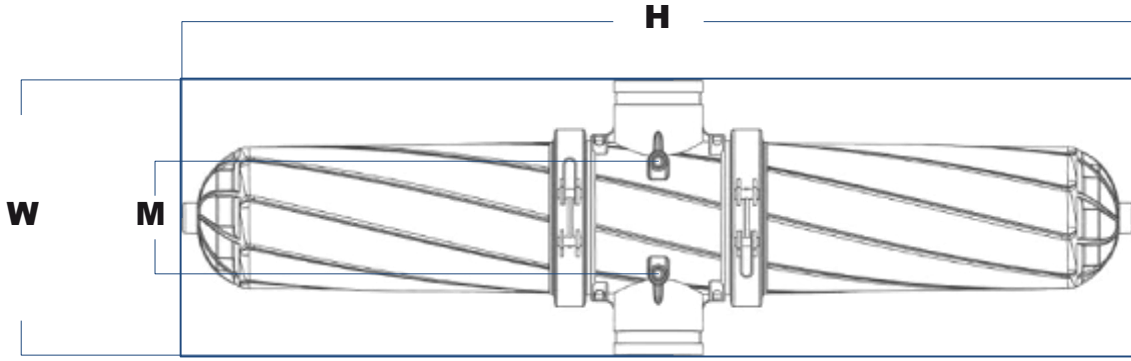

Bağlantı Çapı Connection Diameter	Cinsi Type	W	H	M
inch		mm	mm	mm
3"	Kısa - Short	340	960	140
	Uzun - Long		1200	
4"	Kısa - Short	340	960	140
	Uzun - Long		1200	

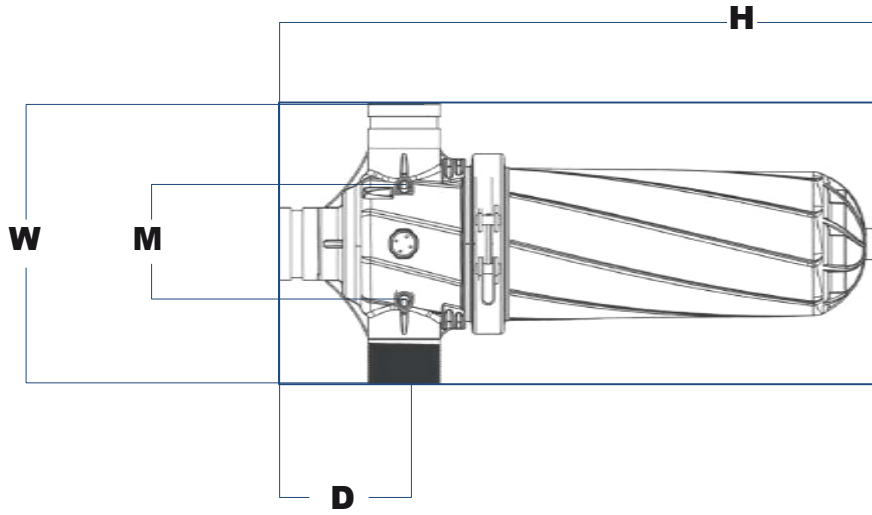

Bağlantı Çapı Connection Diameter	Cinsi Type	W	H	M	D
inch		mm	mm	mm	mm
2"	Kısa - Short	340	630	140	160
	Uzun - Long		740		
2 ½"	Kısa - Short	340	630	140	160
	Uzun - Long		740		
3"	Kısa - Short	340	630	140	160
	Uzun - Long		740		

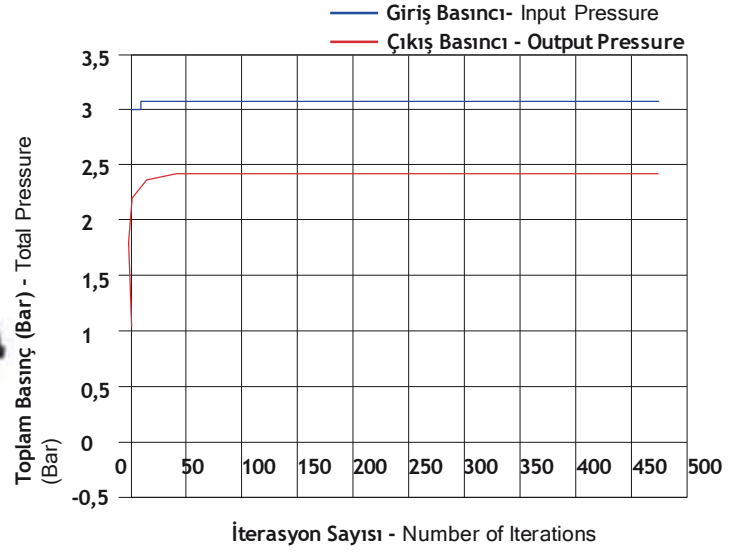

### PLASTİK DİSK FİLTRELER BASINÇ KAYBI

Plastic Disc Filters Head Loss

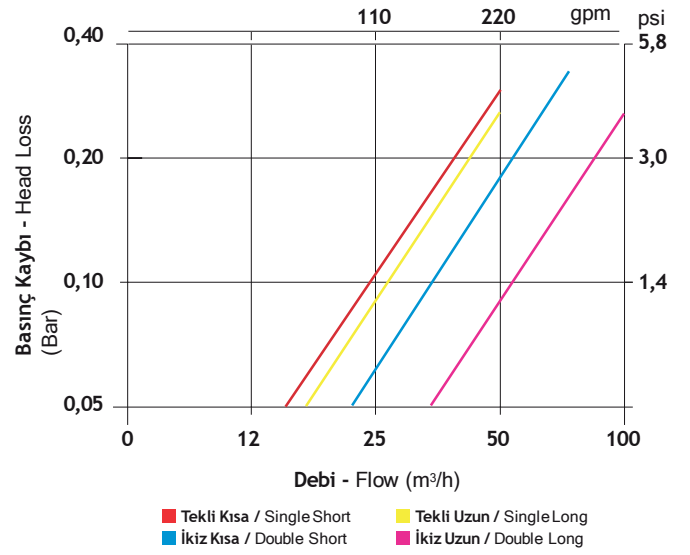

### PLASTİK ELEK FİLTRELER BASINÇ KAYBI

Plastic Screen Filters Head Loss

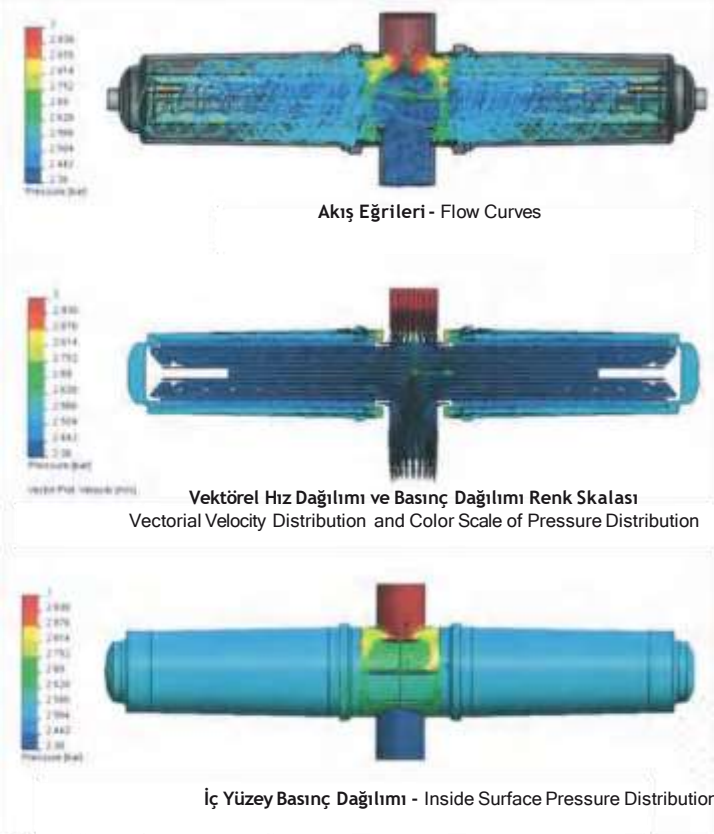
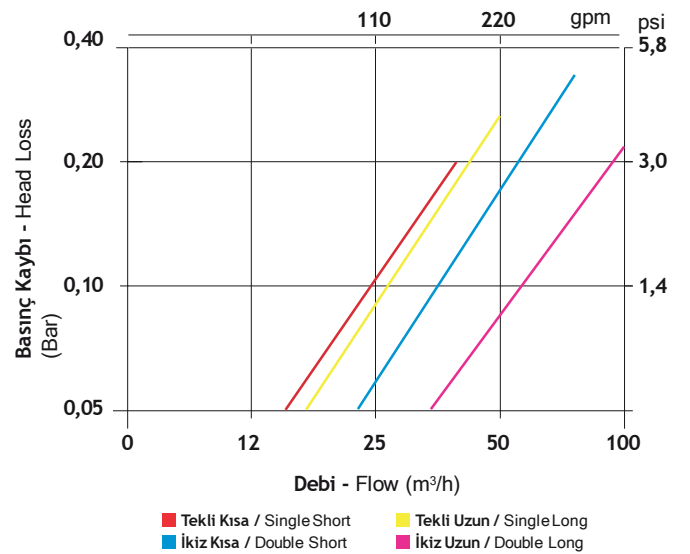

## TEKNİK DETAYLAR/ TECHNICAL SPECS

Gövde - Body	Cam elyaf katkılı poliamid - Fiberglass reinforced polyamide
İç Takım - Cartridge	PP Disk - PP Disc Paslanmaz çelik elek - Stainless steel screen
Kelepçe - Clamp	Mühendislik Plastiği - Engineering Plastic Paslanmaz çelik - Stainless steel
Contalar - O rings	Kauçuk - Rubber

- ✓ Verilen sonuçlar 130 mikron disk ve elek iç takımlar içindir. pH>4 | Maksimum sıcaklık 60 C | Maksimum basınç 10 Bar
- ✓ Given results are for 130 micron disc and screen cartridges. pH>4 | Maximum temperature 60 C | Maximum pressure 10 Bar



## Y TİP DİSK FİLTRELER / Y TYPE DISC FILTERS

+plus



T: Dişli • Threaded  
BSPT | NPT

■ 130 micron / 120 mesh

Bağlantı Çapı Connection Diameter	Ürün Kodu Product Code	Bağlantı Tipi Connection Type	Kapasite Capacity	Filtrasyon Yüzeği Filtration Surface	Ambalaj Miktarı Packing Quantity		Koli Tipi Box Type
inch			m <sup>3</sup> /h	cm <sup>2</sup>	Poşet / Bag	Koli / Box	
1 ½"	800-112-01-01	BSPT x BSPT	20	559,20	1	15	B-2
	800-112-01-11						
2"	800-200-01-01	BSPT x BSPT	25	559,20	1	15	B-2
	800-200-01-11	NPT x NPT					

## Y TİP DİSK FİLTRELER / Y TYPE DISC FILTERS

midi



T: Dişli • Threaded  
BSPT | NPT

■ 130 micron / 120 mesh

Bağlantı Çapı Connection Diameter	Ürün Kodu Product Code	Bağlantı Tipi Connection Type	Kapasite Capacity	Filtrasyon Yüzeği Filtration Surface	Ambalaj Miktarı Packing Quantity		Koli Tipi Box Type
inch			m <sup>3</sup> /h	cm <sup>2</sup>	Poşet / Bag	Koli / Box	
1 ¼"	800-114-02-01	BSPT x BSPT	10	311,96	1	32	B-2
	800-114-02-11	NPT x NPT					
1 ½"	800-112-02-01	BSPT x BSPT	15	311,96	1	32	B-2
	800-112-02-11	NPT x NPT					

## Y TİP DİSK FİLTRELER / Y TYPE DISC FILTERS

mini



T: Dişli • Threaded  
BSPT | NPT

■ 130 micron / 120 mesh

Bağlantı Çapı Connection Diameter	Ürün Kodu Product Code	Bağlantı Tipi Connection Type	Kapasite Capacity	Filtrasyon Yüzeği Filtration Surface	Ambalaj Miktarı Packing Quantity		Koli Tipi Box Type
inch			m <sup>3</sup> /h	cm <sup>2</sup>	Poşet / Bag	Koli / Box	
¾"	800-034-03-01	BSPT x BSPT	6	172,25	1	60	B-2
	800-034-03-11						
1"	800-100-03-01	BSPT x BSPT	7	172,25	1	60	B-2
	800-100-03-11	NPT x NPT					



## Y TİP ELEK FİLTRELER / Y TYPE SCREEN FILTERS

+plus

T: Dişli • Threaded  
BSPT | NPT

■ 530 micron / 35 mesh    ■ 130 micron / 120 mesh ■  
■ 200 micron / 75 mesh    ■ 100 micron / 150 mesh ■

Bağlantı Çapı Connection Diameter	Ürün Kodu Product Code	Bağlantı Tipi Connection Type	Kapasite Capacity	Filtrasyon Yüzeyi Filtration Surface	Ambalaj Miktarı Packing Quantity		Koli Tipi Box Type
inch			m <sup>3</sup> /h	cm <sup>2</sup>	Poşet / Bag	Koli / Box	
1 ½"	800-112-01-02	BSPT x BSPT	20	525,43	1	15	B-2
	800-112-01-12						
2"	800-200-01-02	BSPT x BSPT	25	525,43	1	15	B-2
	800-200-01-12	NPT x NPT					



## Y TİP ELEK FİLTRELER / Y TYPE SCREEN FILTERS

midi

T: Dişli • Threaded  
BSPT | NPT

■ 530 micron / 35 mesh    ■ 130 micron / 120 mesh ■  
■ 200 micron / 75 mesh    ■ 100 micron / 150 mesh ■

Bağlantı Çapı Connection Diameter	Ürün Kodu Product Code	Bağlantı Tipi Connection Type	Kapasite Capacity	Filtrasyon Yüzeyi Filtration Surface	Ambalaj Miktarı Packing Quantity		Koli Tipi Box Type
inch			m <sup>3</sup> /h	cm <sup>2</sup>	Poşet / Bag	Koli / Box	
1 ¼"	800-114-02-02	BSPT x BSPT	10	322,54	1	32	B-2
	800-114-02-12						
1 ½"	800-112-02-02	BSPT x BSPT	15	322,54	1	32	B-2
	800-112-02-12	NPT x NPT					



## Y TİP ELEK FİLTRELER / Y TYPE SCREEN FILTERS

mini

T: Dişli • Threaded  
BSPT | NPT

■ 530 micron / 35 mesh    ■ 130 micron / 120 mesh ■  
■ 200 micron / 75 mesh    ■ 100 micron / 150 mesh ■

Bağlantı Çapı Connection Diameter	Ürün Kodu Product Code	Bağlantı Tipi Connection Type	Kapasite Capacity	Filtrasyon Yüzeyi Filtration Surface	Ambalaj Miktarı Packing Quantity		Koli Tipi Box Type
inch			m <sup>3</sup> /h	cm <sup>2</sup>	Poşet / Bag	Koli / Box	
¾"	800-034-03-02	BSPT x BSPT	6	178,47	1	60	B-2
	800-034-03-12						
1"	800-100-03-02	BSPT x BSPT	7	178,47	1	60	B-2
	800-100-03-12	NPT x NPT					

## Y TİP DİSK FİLTRELER / Y TYPE DISC FILTERS

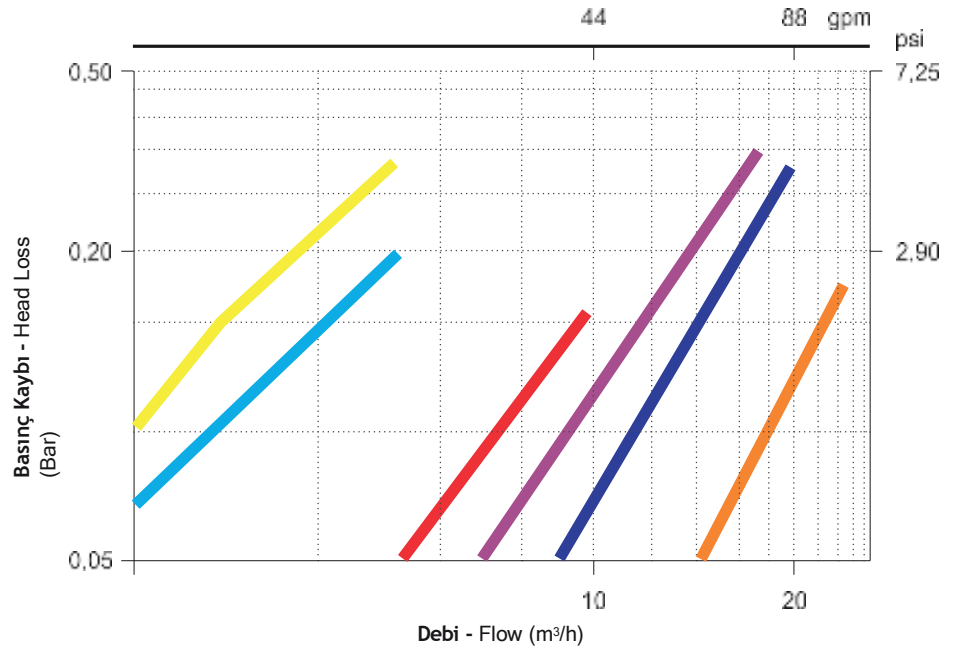
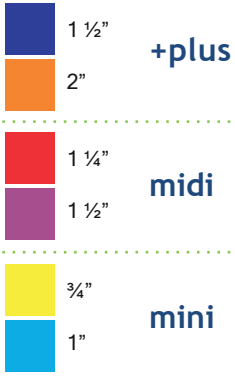

## Y TİP ELEK FİLTRELER / Y TYPE SCREEN FILTERS

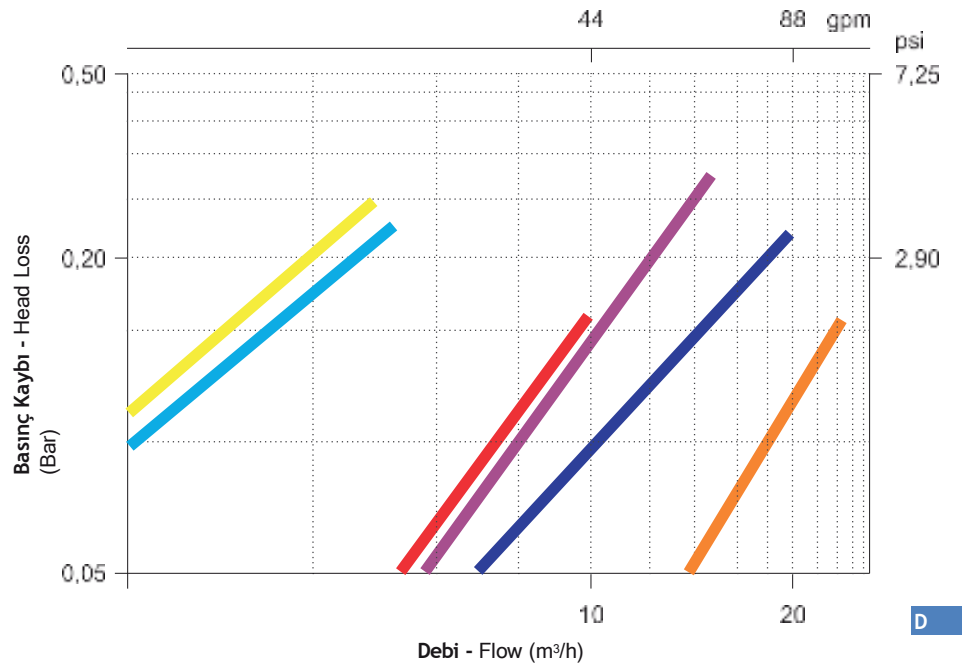
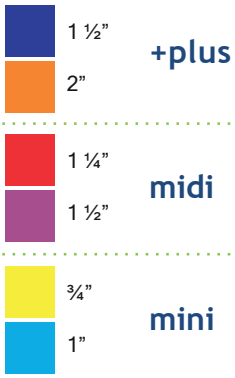

## TEKNİK DETAYLAR/ TECHNICAL SPECS

Gövde - Body	Polipropilen - Polypropylene
İç Takım - Cartridge	PP Disk - PP Disc Paslanmaz çelik elek - Stainless steel screen
Contalar - O rings	Kauçuk - Rubber

Verilen sonuçlar 130 mikron disk ve elek iç takımlar içindir.  
pH>4 | Maksimum sıcaklık 60 C | Maksimum basınç 10 Bar  
Given results are for 130 micron disc and screen cartridges.  
pH>4 | Maximum temperature 60 C | Maximum pressure 10 Bar

## ÖLÇÜLER / DIMENSIONS

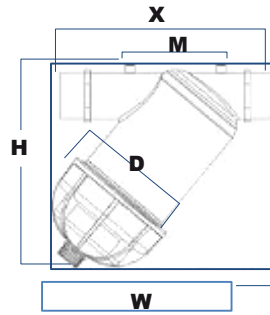

Cinsi Type	Bağlantı Çapı Connection Diameter	X W M H				
		mm	mm	mm	mm	mm
<b>+plus</b>	1 1/2" x 1 1/2"					
	2" x 2"	263	275	110	250	143
<b>midi</b>	1 1/4" x 1 1/4"					
	1 1/2" x 1 1/2"	230	225	95	205	115
<b>mini</b>	3/4" x 3/4"					
	1" x 1"	170	182	70	170	93,5

## PLASTİK FİLTRE İÇ TAKIM DİSK / DISC CARTRIDGE FOR PLASTIC FILTER

130 micron / 120 mesh ■

Ürün Kodu Product Code	Ürün Ölçüleri Product Dimensions	Ambalaj Miktarı Packing Quantity	Koli Tipi Box Type
Tip / Type		Koli/Box	
999-234-00-02	2"-2½"-3"-4" Uzun	8	B-2



## FİLTRE İÇ TAKIM ELEK / SCREEN CARTRIDGE

■ 530 micron / 35 mesh    130 micron / 120 mesh ■  
■ 200 micron / 75 mesh    100 micron / 150 mesh ■

Ürün Kodu Product Code	Ürün Ölçüleri Product Dimensions	Ambalaj Miktarı Packing Quantity	Koli Tipi Box Type
Tip / Type		Koli/Box	
997-025-00-01	25	28	B-2
997-030-00-01	37,5	16	B-2
997-040-00-01	50	12	B-2



## METAL FİLTRE İÇ TAKIM DİSK / DISC CARTRIDGE FOR METAL FILTER

130 micron / 120 mesh ■

Ürün Kodu Product Code	Ürün Ölçüleri Product Dimensions	Ambalaj Miktarı Packing Quantity	Koli Tipi Box Type
Tip / Type		Koli/Box	
998-025-35-01	35	12	B-2
998-030-40-01	40	12	B-2
998-040-50-01	50	8	B-2
998-050-60-01	60	8	B-2



## Y TİPİ FİLTRE İÇ TAKIM DİSK / DISC CARTRIDGE FOR Y TYPE FILTER

130 micron / 120 mesh ■

Ürün Kodu Product Code	Açıklama Explanation	Ambalaj Miktarı Packing Quantity	Koli Tipi Box Type
		Koli/Box	
899-200-02-01	midi	54	B-1
899-300-03-01	mini	112	B-1



## Y TİPİ FİLTRE İÇ TAKIM ELEK / SCREEN CARTRIDGE FOR Y TYPE FILTER

■ 530 micron / 35 mesh    130 micron / 120 mesh ■  
■ 200 micron / 75 mesh    100 micron / 150 mesh ■

Ürün Kodu Product Code	Açıklama Explanation	Ambalaj Miktarı Packing Quantity	Koli Tipi Box Type
		Koli/Box	
897-100-01-02	+plus	28	B-1
897-200-02-02	midi	54	B-1
897-300-03-02	mini	112	B-1



**DT001**

## PPRC WELDING SET CLASSIC

- Double heating elements, 1500 Watt
- Yoke foot
- After sale and spare part guarantee for 2 years
- Classical
- Heating elements made of noncorrosive material.
- All apparatus required for PP welding are available in the toolbox set (20-40 mm)
- All products in the set comply with DIN norms



**DT002**

## PPRC WELDING MACHINE SET ECONOMIC

- 800 Watt
- Yoke foot
- After sale and spare part guarantee for 2 years
- Classical
- Heating elements made of noncorrosive material.
- All apparatus required for PP welding are available in the toolbox set (20-32 mm)
- All products in the set comply with DIN norms



**DT004**

## PLASTIC PIPE CUTTER CLASSIC

- 16-42 mm
- First quality stainless steel blade
- Handle coated by special paint
- After sale support and unlimited spare part guarantee for 1 year
- Cutting guarantee in world standards



**DT005**

## PLASTIC PIPE CUTTER AUTOMATIC

- 16-42 mm
- First quality stainless steel blade
- Handle coated by special paint
- After sale support and unlimited spare part guarantee for 1 year
- Cutting guarantee in world standards







## DATKA Sprinklers













DTK001-BSP		<b>DATKA70 - BSP</b> Standart Nozzles : 10mm-12mm- 14mm16mm- 18mm Inlet Size : 1,5" Female Connection	72 pcs
DTK001-NPT		<b>DATKA70 - NPT</b> Standart Nozzles : 10mm-12mm- 14mm16mm- 18mm Inlet Size : 1,5" Female Connection	
DTK002-BSP		<b>DATKA80 - BSP</b> Standart Nozzles : 10mm-12mm- 14mm16mm- 18mm-20mm-22mm Inlet Size : 2" Female Connection BodyAngle : 28°	72 pcs
DTK002-NPT		<b>DATKA80 - NPT</b> Standart Nozzles : 10mm-12mm- 14mm16mm- 18mm-20mm-22mm Inlet Size : 2" Female Connection BodyAngle : 28°	
DTK003-BSP		<b>DATKA100 - BSP</b> Standart Nozzles : 18mm - 20mm-22mm- 24mm-26mm Inlet Size : 2 " Female Connection	60 pcs
DTK003-NPT		<b>DATKA100 - NPT</b> Standart Nozzles :18mm- 20mm- 22mm24mm- 26mm Inlet Size : 2 " Female Connection	
DTK004-BSP		<b>DATKA120 - BSP</b> Standart Nozzles : 20mm-22mm- 24mm- 26mm-28mm Inlet Size : 2 " Female Connection	60 pcs
DTK004-NPT		<b>DATKA120 - NPT</b> Standart Nozzles : 20mm-22mm- 24mm- 26mm-28mm Inlet Size : 2 " Female Connection	

DTK005		<p><b>DATKA150</b>  Standart Nozzles : 22mm - 24mm -26mm -  28mm - 30mm-32mm  Inlet Size : Flange Connection (130mmx 78mm )  BodyAngle : 24°</p>	21 pcs
DTK006		<p><b>DATKA200</b>  Standart Nozzles : 28mm-30mm-32mm-34mm  Optionally Nozzles are : 24mm -36mm - 38mm -  40mm- 42mm  Inlet Size : Flange Connection (145mmx 78mm )  BodyAngle : 23°</p>	12 PCS L: 135cm W: 100cm H: 115Cm
DTK007- BSP		<p><b>DATKA TURFJET</b>  ( Small Turbine Drive Raingun for Horse  Arenas and Turf Irrigation ,orSynthetic Turf  Cooling )  Nozzles : 12mm- 14mm -16mm -  18mm - 20mm - 22mm</p>	72 pcs
DTK007- NPT		<p><b>DATKA TURFJET</b>  ( Small Turbine Drive Raingun for Horse  Arenas and Turf Irrigation ,orSynthetic Turf  Cooling )  Nozzles : 12mm- 14mm -16mm -  18mm - 20mm - 22mm</p>	72 pcs
DTK008-BSP		<p><b>DATKA PIVOTJET - BSP</b>  ( Center Pivot End Gun or Windy Fields  Raingun ) Nozzles Aluminium :</p>	35 pcs
DTK008-NPT		<p><b>DATKA PIVOTJET - NPT</b>  ( Center Pivot End Gun or Windy Fields  Raingun ) Nozzles Aluminium :</p>	









DTK009-BSP		<b>DATKA70 DUSTJET - BSP</b> Dust For Mining Nozzles : 14mm - 16mm - 18mm - 20mm Body Angle 43° Inlet Size 2 " Female BSP	72 pcs
DTK009-NPT		<b>DATKA70 DUSTJET - NPT</b> Dust Control Raingun For Mining Nozzles : 14mm - 16mm - 18mm - 20mm Body Angle 43° Inlet Size 2 " Female NPT	72 pcs
DTK010-BSP		<b>DATKA100 DUSTJET - BSP</b> Dust Control Raingun For Mining Nozzles : 18mm - 20mm - 22mm - 24mm - 26mm - 28mm Body Angle 43° Inlet Size 2 " Female BSP	60 pcs
DTK010-NPT		<b>DATKA100 DUSTJET - NPT</b> Dust Control Raingun For Mining Nozzles :18mm - 20mm - 22mm - 24mm - 26mm - 28mm Body Angle 43° Inlet Size 2 " Female NPT	
DTK011		<b>DATKA150 Super DUSTJET</b> Dust Control Raingun For Mining Nozzles : 22mm - 24mm - 26mm - 28mm - 30mm - 32mm Body Angle 43° Inlet Size : 78mm x 130 mm Flange Connection	21 pcs
DTK012		<b>DATKA150 Super DUSTJET</b> Dust Control Raingun For Mining Suitable For Seawater Application - Special Designed Double Lower Body Bearings and SS accesories Nozzles : 22mm - 24mm - 26mm - 28mm - 30mm - 32mm Body Angle 43° Inlet Size : 78mm x 130 mm	21 pcs



DATKA Sprinklers			
DTK020		<p><b>DATKA ATOM14 FC</b>            Full Circle 3/4" Impact Sprinkler            Standart Nozzle :            5mm(Yellow) - 4mm(Black)            Front &amp; Back Water Breaker            Body Angle 25° &amp; 25° Inlet Size :            3/4" male 1 Box 60 PCS</p>	2160 PCS
DTK021		<p><b>DATKA ATOM14 WFC</b>            Full Circle Wedge Drive 3/4"            Impact Sprinkler            Standart Nozzle : 4mm(RED)            -            2,5mm(Turquoise)            Body Angle 25° &amp; 25° Inlet Size :            3/4" male 1 Box 60 PCS</p>	2160 PCS
DTK022		<p><b>DATKA ATOM14 WWB</b>            Full Circle Wedge Drive 3/4"            Impact Sprinkler            Standart Nozzle : 4mm(RED)            -            2,5mm(Turquoise)            With Weights + Front Breaker            Body Angle 25° &amp; 25° Inlet Size :            3/4" male 1 Box 60 PCS</p>	2160 PCS
DTK020PC		<p><b>DATKA ATOM14 PC</b>            Full Circle &amp; Part Circle 3/4"            Impact Sprinkler            Standart Nozzle : 4,5mm (Black)            Water            Breaker Body Angle 25°            Inlet Size : 3/4" male 1 Box 50 PCS</p>	1800pcs
DTK025		<p><b>DATKA ATOM15 FC</b>            Full Circle 1" Impact Sprinkler            Standart Nozzles :            6mm(orange) - 3,2mm(dark            green)            Body Angle 22° &amp; 27°            Inlet Size : 1" Female Female 1 Box            50</p>	1800 pcs
DTK026		<p><b>DATKA ATOM15 PC</b>            1" Part or Full circle Impact Sprinkler            Standart Nozzles : 5.5mm            (White) Body Angle            23°            Inlet Size : 1" Female Female 1 Box            40            PCS</p>	1440 pcs
DTK027		<p><b>DATKA ATOM15 LF</b>            Full Circle 1" Impact Sprinkler            Standart Nozzles : 4,5 mm            (Black) x 2,5mm            (Turquoise)            Body Angle 22° &amp; 27° Inlet Size : 1"            Female 1 Box 50 PCS</p>	1800 pcs

DTK028		<p><b>DATKA ATOM15 LF PC</b>  1" Part or Full circle Impact  Sprinkler Standart Nozzles :  4.5mm ( Black ) Body Angle 23°</p>	1440 pcs
DTK030		<p><b>DATKA ATOM15 LA</b>  Full Circle 1" Impact Sprinkler ,  Undertree Irrigation Or Pivot  Sprinklers Standart Nozzles : 5  mm (White) - □ 2,5 mm(  turquoise)  Body Angle 7° &amp; 10° Inlet Size : 1"  Female 1 Box 50 PCS</p>	1800 pcs







DATKA Sprinklers			
DTK054	<p><b>DATKA ATOM22 ECO FC - BSP</b> Plastic Spindle and Full Circle Standart Nozzles : 6mm - 8mm -10mm Inlet Size : 1"Female</p>		900 pcs
DTK055	<p><b>DATKA ATOM22 ECO FC- NPT</b> Plastic Spindle and Full Circle Standart Nozzles : 6mm - 8mm -10mm Inlet Size : 1"</p>		
DTK056FC	<p><b>DATKA ATOM22 FC- BSP</b> Brass Spindle and Part Circle Standart Nozzles : 6mm - 8mm - 10mm Inlet Size : 1" Female</p>		432 pcs
DTK057FC	<p><b>DATKA ATOM22 FC - NPT</b> Brass Spindle and Part Circle Standart Nozzles : 6mm - 8mm - 10mm Inlet Size : 1" Female</p>		
DTK056	<p><b>DATKA ATOM22 - BSP</b> Brass Spindle and Part Circle Standart Nozzles : 6mm - 8mm - 10mm Inlet Size : 1" Female</p>		432 pcs
DTK057	<p><b>DATKA ATOM22 - NPT</b> Brass Spindle and Part Circle Standart Nozzles : 6mm - 8mm - 10mm Inlet Size : 1" Female</p>		
DTK058FC	<p><b>DATKA ATOM28 X FC - BSP</b> Aluminium body and aluminium lower body Full Circle Standart Nozzles : 10mm - 12mm - 14mm Inlet Size : 1,25" Female</p>		300 pcs
DTK059FC	<p><b>DATKA ATOM28 X FC - NPT</b> Aluminium body and aluminium lower body Full Circle Standart Nozzles : 10mm - 12mm - 14mm Inlet Size : 1,25" Female</p>		

DTK058	<b>DATKA ATOM28 X - BSP</b> Aluminium body and aluminium lower body Full Circle Standart Nozzles : 10mm - 12mm -14mm Inlet Size :1,25" Female		300 pcs
DTK059	<b>DATKA ATOM28 X - NPT</b> Aluminium body and aluminium lower body full Circle Standart Nozzles : 10mm - 12mm -14mm Inlet Size : 1,25" Female		
DTK062FC	<b>DATKA ATOM28 ECO FC - BSP</b> Aluminium body and aluminium lower body Full Circle Standart Nozzles : 10mm - 12mm - 14mm Inlet Size		300 pcs
DTK063FC	<b>DATKA ATOM28 ECO FC - NPT</b> Aluminium body and aluminium lower body full Circle Standart Nozzles : 10mm - 12mm - 14mm Inlet Size		
DTK062	<b>DATKA ATOM28 - BSP</b> Brass and Stainless Steel Spindle and Part Circle Full Metal Body Standart Nozzles : 10mm - 12mm - 14mm Inlet Size : 1,5" Female		300 pcs
DTK063	<b>DATKA ATOM28 - NPT</b> Brass and Stainless Steel Spindle and Part Circle Full Metal Body Standart Nozzles : 10mm - 12mm - 14mm Inlet Size : 1,5" Female		
DTK60FC	<b>DATKA ATOM30 FC</b> Brass and Stainless Steel Spindle Full Circle Standart Nozzle : 8mm-10mm-12mm-14mm Inlet Size : 1,5" Female 1 Box - 1 pcs Sprinkler		180 pcs
DTK61FC			
DTK60PC	<b>DATKA ATOM30 PC</b> Aluminium body, Brass and Stainless Steel Spindle Full & Part Circle Standart Nozzles : 8mm -10mm - 12mm - 14mm Inlet Size : 1,5" Female 1 Box - 1 pcs Sprinkler		300 pcs
DTK61PC			
DTK064	<b>DATKA ATOM35 - BSP</b> Brass and Stainless Steel Spindle and Part Circle Standart Aluminium Nozzles : 12mm - 14mm - 16mm - 18mm Inlet Size : 1,5" Female		90 pcs
DTK065	<b>DATKA ATOM35 - NPT</b> Brass and Stainless Steel Spindle and Part Circle Standart Aluminium Nozzles : 12mm -14mm - 16mm - 18mm Inlet Size : 1,5" Female		

DTK0 66	<p align="center"><b>DATKA ATOM40S - BSP</b></p> <p>Brass and Stainless Steel Spindle and Part Circle Standart Nozzles : 14mm - 16mm - 18mm-20mm Inlet Size : 2 " Female</p>		90 pcs
DTK0 67	<p align="center"><b>DATKA ATOM40S - NPT</b></p> <p>Brass and Stainless Steel Spindle and Part Circle Standart Nozzles : 14mm - 16mm - 18mm -20mm Inlet Size : 2 " Female</p>		
DTK0 68	<p align="center"><b>DATKA ATOM42 FC - BSP</b></p> <p>High Performance Full Circle Impact Sprinkler Standart Nozzles : 14mm -16mm - 18mm - 20mm - 22mm Inlet Size : 2" Female</p>		90 pcs
DTK0 69	<p align="center"><b>DATKA ATOM42 FC - NPT</b></p> <p>High Performance Full Circle Impact Sprinkler Standart Nozzles : 14mm -16mm - 18mm - 20mm - 22mm Inlet Size : 2" Female</p>		

DATKA Sprinklers			
DTK090E	<p><b>Mini ECO 1" PVC Connection Stand</b>            Water Line Pipe 1" PVC            Pipe Height : 100 cm PVC            Maximum Work Pressure : 4 kg/cm<sup>2</sup> ( 56 psi) Weight : 4 kg            (Recommended 1" Sprinkler )</p>		10 PCS
DTK090-BSP			
DTK091-NPT	<p><b>Mini ECO 1" Connection Stand</b>            Water Line Pipe 1"            Aluminium Pipe Height : 75 cm            Maximum Work Pressure : 4 kg/cm<sup>2</sup> ( 56 psi)            Weight : 4 kg (Recommended For 1" Atom Series )</p>		
DTK092 - BSP	<p><b>PRO ECO 1,5" Connection Stand Adjustable Height Legs</b>            Main Water Pipe 1,5 " - 85 cm            Maximum Work Pressure : 4 kg/cm<sup>2</sup> ( 56 psi)            Weight : 8 kg (Recommended For 1,5" Atom Series)</p>		10 PCS
DTK093 - NPT			
DTK092P4 - BSP	<p><b>PRO ECO 4 Pod 1,5" Connection Stand Adjustable Height Legs</b>            Main Water Pipe 1,5 " - 85 cm Maximum Work Pressure : 4 kg/cm<sup>2</sup> ( 56 psi) Weight : 10 kg (Recommended Atom35 and JET35 Series)</p>		10 PCS
DTK093P4 - NPT			
DTK092P4 - BSP	<p><b>PRO ECO 4 Pod 2" QC Connection</b></p>		
DTK093P4 - NPT	<p><b>Stand Adjustable Height Legs</b>            Main Water Pipe 2" - 85 cm Maximum Work Pressure : 4 kg/cm<sup>2</sup> ( 56 psi)            Weight : 11 kg (Recommended Atom40 and Atom42 Series)</p>		
DTK094 - BSP	<p><b>3 Pod 2" Connection Stand With Quick Coupling Adjustable Height Legs</b>            Water Input : 2" Water Output : 1,5 " Male            Quick Coupling Pipe Height : 85 cm            Maximum Work Pressure : 4 kg/cm<sup>2</sup> ( 56 psi) Weight : 12 kg Suitable for 1,5" Inlet Rainguns and Sprinklers</p>		10 pcs
DTK095 -NPT			
Motopump	<p>Male Ø75 QC For Connection Starts Ø75 For Sprinkler System 2" Female Screw Suitable for Connection Stant for use with HDPE pipes with quick coupling</p>		

**Our connection stands are painted with powder paint as a standard. Optional powder paint on electro galvanized coating or powder paint varnish on electro galvanized coating are available.**

DTK096- BSP	<b>4 Pod 2" Connection Stand With Quick Coupling Adjustable Legs</b> Water Input : 2" Water Output : 2 " Male Quick Coupling Pipe Height : 100 cm Maximum Work Pressure : 5 kg/cm2 ( 70 psi) Weight : 13 kg		10 PCS
DTK097- NPT			
DTK096 A - BSP	<b>4 Pod 2" Connection Stand With Quick Coupling Adjustable Legs</b> Water Input : 2" Water Output : 1,5" Male Quick Coupling Pipe Height : 100 cm Maximum Work Pressure : 5 kg/cm2 ( 70 psi) Weight : 13 kg		10 PCS
DTK097A- NPT			
DTK098- BSP	<b>4 Pod 2" Connection Stand Adjustable Legs</b> Water Pipe Line : 2 " Pipe Height : 100 cm Maximum Work Pressure : 5 kg/cm2 ( 70 psi) Weight : 12 kg		10 PCS
DTK099 - NPT			
DTK10 0 -BSP	<b>4 Pod 2,5 " Connection Stand Adjustable Legs</b> Water Pipe Line : 2,5 " Pipe Height : 75 cm Maximum Work Pressure : 5 kg/cm2 ( 70 psi) Weight : 14 kg		10 PCS
DTK10 2 -BSP			
DTK103 - BSP	<b>High PRO ECO 1,5" Connection Stand</b> Water Line Pipe 1,5 " Pipe Height : 85 cm + 85 cm = 170cm (With Mansoon) Maximum Work Pressure : 3 kg/cm2 ( 56 psi) Weight : 9 kg (Recommended For 1,5" Inlet Atom Sprinklers)		10 PCS
DTK1 04- NPT			
DTK105- BSP	<b>High 4 Pod 2" Connection Stand With QuickCoupling</b> Adjustable Legs Water Input : 2" Water Output :2 " Pipe Height : 100 cm + 100cm = 200 cm ( With Mansoon) Maximum Work Pressure : 4 kg/cm2 ( 70 psi) Weight : 19 kg		10 PCS
DTK1 06- NPT			

Our connection stands are painted with powder paint as a standard. Optional powder paint on electro galvanized coating or powder paint varnish on electro galvanized coating are available.

# NO MORE MESSY QUICK & EASY

THE LATEST TECHNOLOGY IN PIPE SEALING

Will not leak out.



ЗАКОНЧИЛАСЬ ЭРА ФУМ ЛЕНТЫ,  
ЛЬНЯНОГО ГЕРМЕТИКА И ПАСТЫ

ПОСЛЕДНИЕ ТЕХНОЛОГИИ В ТРУБНОЙ СИСТЕМЕ.

Между вами не протечет вода



Datika Fix  
[www.datka.com.tr](http://www.datka.com.tr)    [info@datkafix.com](mailto:info@datkafix.com)    [www.datkafix.com](http://www.datkafix.com)  
 Menemen Adıyaman Caddesi, 296 Sokak, 619, Yenimahalle 06230 Ankara  
 Office: +90 312 385 50 31(Pbx)

Datika Fix  
[www.datka.com.tr](http://www.datka.com.tr)    [info@datkafix.com](mailto:info@datkafix.com)    [www.datkafix.com](http://www.datkafix.com)  
 Menemen Adıyaman Caddesi, 296 Sokak, 619, Yenimahalle / ANKARA, TÜRKİYE  
 Офис : +90 312 385 50 31(Pbx)

## 100% leak proof sealing solution for metal threaded joints

- Very high setting speed even at cold temperatures (0°C)
- Fixed parts can be disassembled by hand tools



## 100% герметичное решение для металлических резьбовых соединений

- Очень высокая скорость отвердевания даже при низких температурах (0 °С)
- Неразъемные детали можно разобрать с помощью ручных инструментов.



### Features

- Suitable for metal-metal and plastic-metal threaded connections
- Drinking water approval for cold/hot water applications
- Keeps its sealing properties against shocks & vibrations long after the application
- No dirt with its non-dripping formulation

### Application

- Close-fitting metal pipe threads where all kinds of water, oil, grease, and many chemicals pass
- Pressure vessels
- Air compressors
- Areas where resistance against vibration is required
- Hydraulic systems and tanks
- Suitable for Type H thick metal thread parts according to TSE EN 781-1 Standard

### Характеристики

- Подходит для резьбовых соединений металл-металл и пластик-металл.
- Подходит для применения в области питьевой воды
- Отсутствует капиллярная утечка формулы
- Сохраняет свои герметизирующие свойства против ударов и вибрации долгое время после нанесения

### Область Применения

- Металлические трубные резьбы, через которую проходит вся вода, масло, смазка и многие химикаты.
- Системы под давлением
- Гидравлические системы и резервуары
- Области, где требуется устойчивость к вибрации
- Подходит для металлических резьбовых соединений типа H в соответствии со стандартом TSE EN 781-1
- Компрессоры воздуха/газа

### Usage and Instructions

#### Surface Preparation

- 1) Ensure parts are clean, dry and free from oil and grease
- 2) Applied with a brush or directly from tube.

#### Application

- 1) Apply the adhesive with a 300 µm to leading threads of the male and female fittings.
- 2) Use an Absorbent tissue paper to wipe off excess jointing compound in the direction of the thread.
- 3) Assemble parts and hold on for 24 hours at 22-24°C to ensure full curing of jointing compound.
- 4) For disassembly, use hand tools to remove mating parts.
- 5) When it is hard to disassemble at room temperature, apply local heat and disassemble while hot. Then, remove any residue cured adhesive mechanically and clean parts with a proper solvent, acetone.

### Использование и инструкции

#### Подготовка поверхности

- 1) Убедитесь, что детали чистые, сухие и не содержат масла и смазки
- 2) Нанесите смесь или прямо из тюбика.

#### Способ Применения

- 1) Нанесите клей на наружную и внутреннюю резьбы фитингов по кругу на 300 микрон
- 2) Используйте впитывающую салфетку, чтобы стереть излишки герметика с резьбы.
- 3) Соберите детали и выдержите 24 часа при 22-24 °С, чтобы обеспечить полное затвердевание герметика.
- 4) Для демонтажа используйте ручные инструменты
- 5) Если демонтаж при комнатной температуре затруднителен, нагрейте и разберите в нагретом состоянии. Затем механически удалите остатки затвердевшего клея и очистите детали растворителем или ацетоном.

### Technical Details

- Average handling time : 10 minutes - Conditions: 22°C
- Flash Point: >90°C Method: ASTM D59-05
- Gap Filling : Up to 0.20mm
- Viscosity : 7000 - 8000 cP's ( @20 °C) 32°C
- Method : ISO 2953, Equipment: Breakdown RVT, grade 3
- Solvent: No
- Shelf Life : 24 months
- Temperature range : -50°C / +150°C
- Specific Gravity : 1.030 - 22°C
- Colour : Blue

### Технические подробности

- Среднее время использования : 10 минут Условия: 22 °С
- Цвет : синий
- Заполнение зазора : до 0.20 мм
- Температура хранения : > 93 °С Метод: ASTM D59-05
- Вязкость : 7000-8000 cP (при 20 °C) / метод: ISO 2955, оборудование: Breakdown RVT, классификация 3
- Удельный вес: 1.030 \* 22 °С
- Диапазон температур: -50 °С / + 150 °С
- Срок хранения : 24 месяца
- Единиц : Нет







**datka**

 Mehmet Akif Ersoy Caddesi, 286. Sokak No: 6/19  
Yenimahalle-Ankara / TÜRKİYE

 +90 312 385 50 31

  +90 505 587 35 54

 [www.datka.com.tr](http://www.datka.com.tr)

 [datka@datkald.com](mailto:datka@datkald.com)



**Turkey**  
Discover  
the potential



 /DatkaTurkey